

Phonak Audéo™ L-R/RT.

User Guide

Phonak Audéo L-R
Phonak Audéo L-RT
Phonak Audéo L-R Trial
Phonak Audéo L-RT Trial
Phonak Charger Ease



This user guide is valid for:

Wireless hearing aids 
0459

Charging accessories 

Phonak Audéo L90-R

Phonak Charger Ease

Phonak Audéo L70-R

Phonak Audéo L50-R

Phonak Audéo L30-R

Phonak Audéo L90-RT

Phonak Audéo L70-RT

Phonak Audéo L50-RT

Phonak Audéo L30-RT

Phonak Audéo L-R Trial

Phonak Audéo L-RT Trial

Note that instructions for the activity tracking functions can be found in the myPhonak User Guide.



Your hearing aid and charger details

- ① If no box is checked and you do not know the model of your hearing aid or charging accessories, please ask your hearing care professional.
- ① The hearing aids described in this user guide contain a built-in and non-removable rechargeable lithium-ion battery.
- ① Please also read safety information regarding handling rechargeable hearing aids (chapter 25).

Hearing aid models

- Audéo L-R (L90/L70/L50/L30)
- Audéo L-RT (L90/L70/L50/L30)
- Audéo L-R Trial
- Audéo L-RT Trial

Earpieces

- Dome
- SlimTip
- cShell

Charging accessories

- Phonak Charger Ease
incl. USB cable (< 3 m)

Your hearing aids and chargers have been developed by Phonak – a world leader in hearing solutions based in Zurich, Switzerland.

These premium products are the result of decades of research and expertise and are designed with your well-being in mind. We thank you for making such a great choice and wish you many years of listening pleasure.

Please read the user guide carefully to make sure that you understand and get the best out of your device. Training is not required for handling of this device. A hearing care professional will help set up this device according to your individual preferences during the fitting consultation. For more information regarding features, benefits, set up, use, maintenance or repairs of your hearing aid and accessories, please contact your hearing care professional or the manufacturer representative. Additional information can be found in the datasheet of your product.

Phonak - life is on
www.phonak.com



Contents

Your hearing aid and charger

1. Quick guide 7
2. Parts of the hearing aid and charger 9

Using the charger

3. Preparing the charger 12
4. Charging the hearing aids 13

Using the hearing aid

5. Left and right hearing aid markings 18
6. Putting on the hearing aid 17
7. Removing the hearing aid 19
8. Multi-function button 20
9. On/Off 21
10. Tap Control 22
11. Connectivity overview 23
12. Initial pairing 24
13. Phone calls 26
14. Flight mode 31
15. Rebooting your hearing aid 34
16. myPhonak app overview 35
17. Roger™ overview 36

Further information

18.	Listening in public places (Optional)	37
19.	Operating, transport and storage conditions	38
20.	Care and maintenance	40
21.	Exchanging the earwax protection	43
22.	Service and warranty	54
23.	Compliance information	56
24.	Information and description of symbols	63
25.	Troubleshooting	70
26.	Important safety information	76
27.	For the US market only, complies with the FDA regulations	96

1. Quick guide

Charging your hearing aids

- ① Before using your hearing aid for the first time, it is recommended to charge it for 3 hours.

After placing your hearing aid in the charger, the indicator light on the hearing aid will show the charging state of the battery until it is fully charged. When fully charged the indicator light will be constantly on, i.e. solid green light.



Left & right hearing aid markings

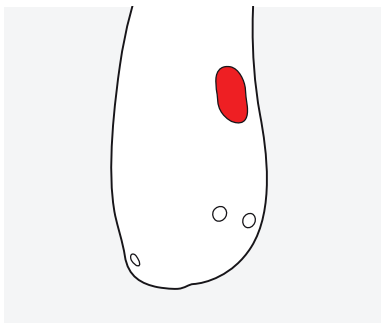

Red marking for right hearing aid.

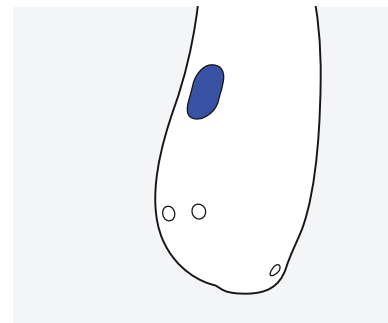

Blue marking for left hearing aid.

Multi-function button with indicator light

The button has several functions, the primary function is as an on/off switch. Together with your hearing care professional, you can decide if it also allows for volume control and/or program change. This is indicated in your individual instructions.

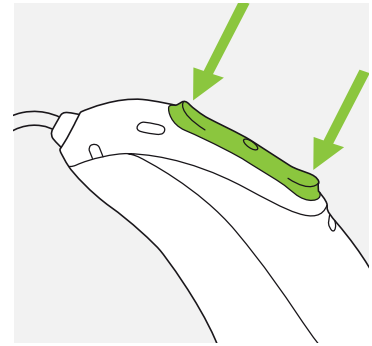

Phone calls: If paired with a Bluetooth® enabled phone, a short press will accept and a long press will reject an incoming call.

On/Off: Firmly press the lower part of the button for 3 seconds until the indicator light blinks.

On: indicator light is solid green

Off: indicator light is solid red

Enter flight mode: When device is off, press the lower part of the button for 7 seconds until the solid orange light appears. Then release the button.

Tap Control (only available for models L90 and L70)

If paired with a Bluetooth® enabled device, multiple functions can be accessed using Tap Control, please refer to chapter 10.

This is also indicated in your individual instructions.

To use Tap Control tap the top of your ear twice.

2. Parts of the hearing aid and charger

The following pictures show the hearing aid model and charger accessories described in this user guide. You can identify your personal models by:

- checking "Your hearing aid and charger details" on page 3.
- comparing your earpieces, hearing aid and charger with the following models.

Possible earpieces

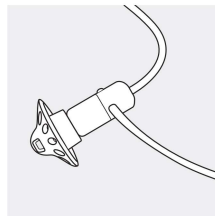

Dome

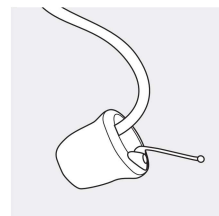

SlimTip

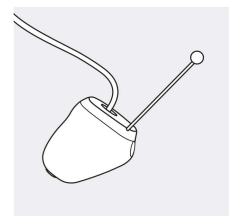

cShell

Audéo L-R/RT

Audéo L-R/RT Trial

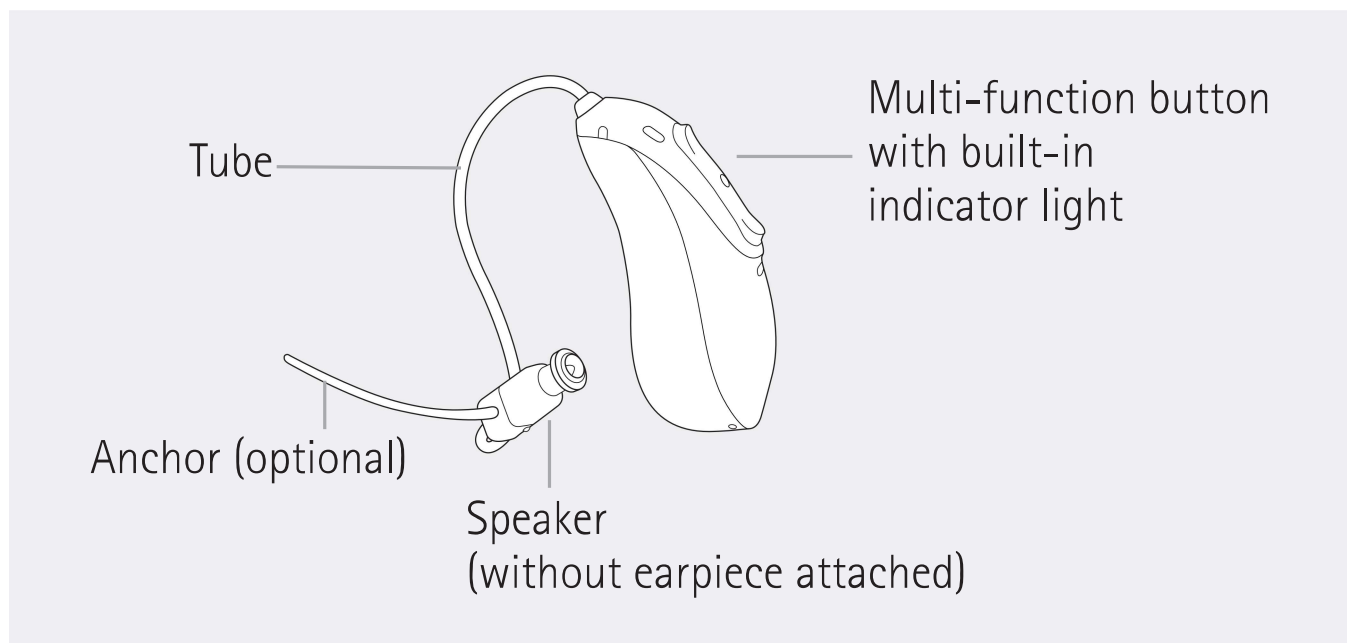

Phonak Charger Ease

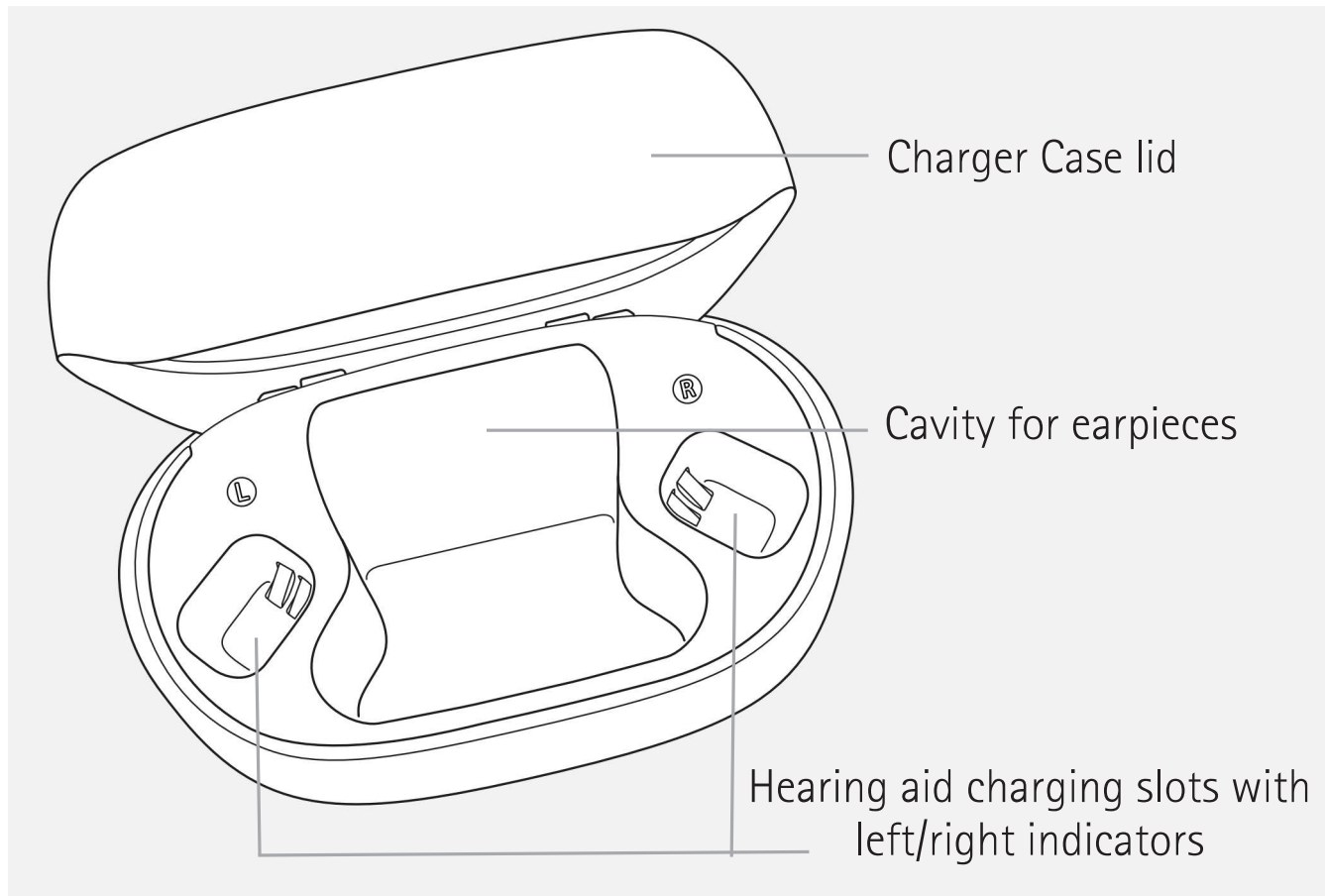

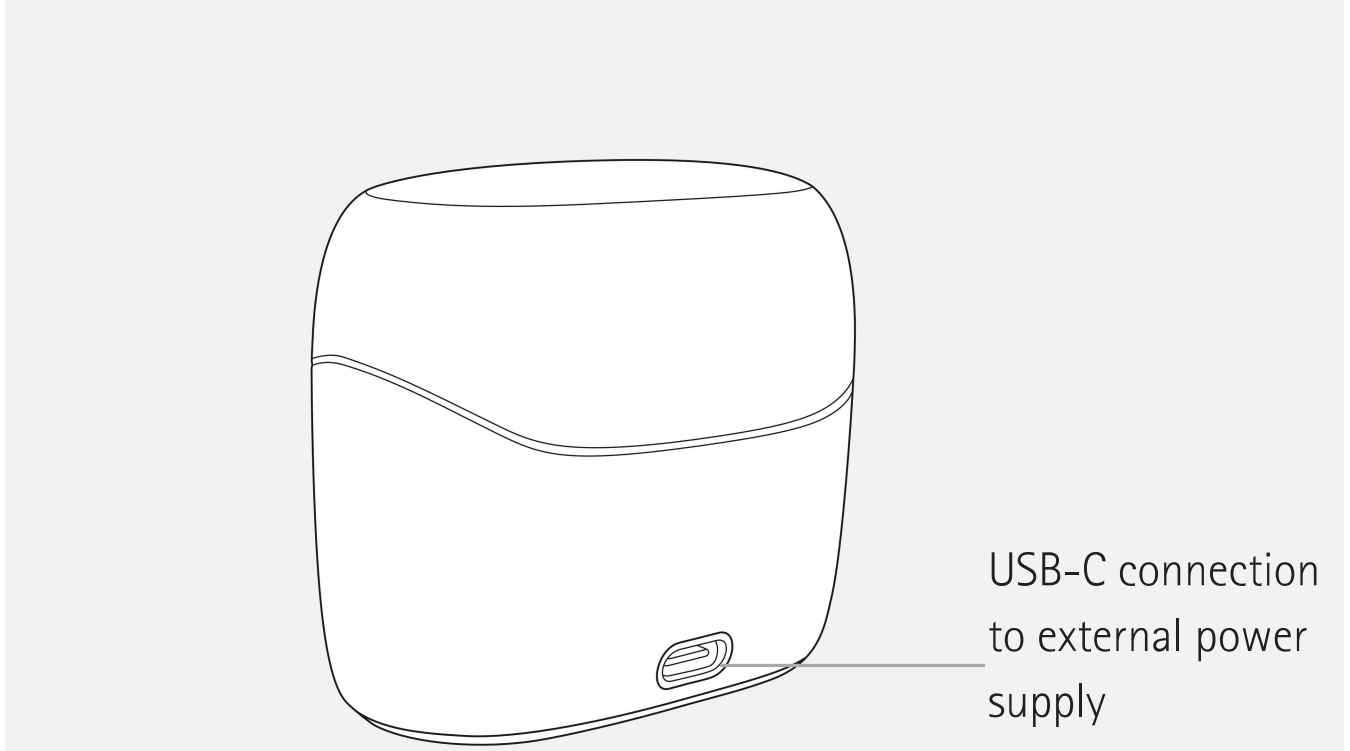

External power supply

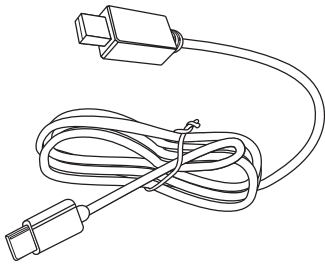

USB cable (< 3 m)

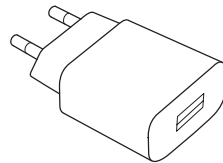

Power supply*

* The power plug is not provided with this product.

3. Preparing the charger

Connecting the power supply

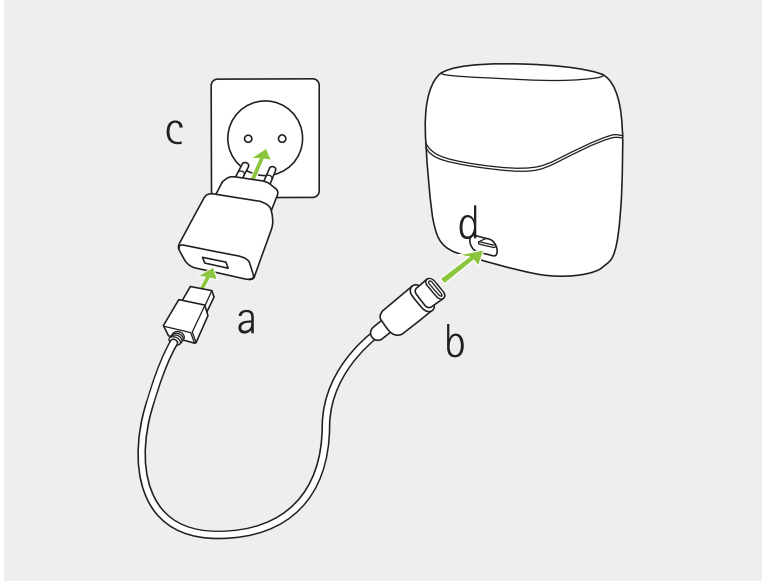

The Phonak Charger Ease may be used with an external power supply that fulfills the specifications in the table below

- a) Plug the larger end of the charging cable into the power supply.
- b) Plug the smaller end into the USB port on the charger.
- c) Plug the power supply into a power outlet.
- d) The indicator light around the USB port will light up green when the charger is connected to the power outlet.

Power supply and charger Specifications

Power supply input voltage	100-240 VAC, 50/60 Hz, current 0.25 A
Power supply output voltage	5 VDC +/-5%, current 1 A
Charger input voltage	5 VDC +/-5%, current 250 mA
USB cable specifications	5 V min. 1 A, USB-A to USB-C, maximum length 3 m

4. Charging the hearing aids

- ① Low power: You will hear two beeps when the hearing aid battery is low. You will have approximately 60 minutes before you have to charge the hearing aids, after this time the hearing aid automatically shuts down (this can vary, depending on the hearing aid settings).
- ① The hearing aid contains a built-in and non-removable rechargeable lithium-ion battery.
- ① Before using your hearing aid for the first time, it is recommended to charge it for 3 hours.
- ① The hearing aid must be dry before charging, see chapter 18.
- ① Please ensure to charge the hearing aid within operating temperature range:
Audéo L R / RT: +5° to +40° Celsius (41° to 104° Fahrenheit)

4.1 Using the Phonak Charger Ease

Please refer to chapter 3 for how to set up the charger.

1.

Insert the hearing aid into the charging slots and the earpieces in the large cavity.

Make sure the left and right hearing aid markings match the left (blue), right (red) indicators next to the charging slots. The hearing aids will automatically switch off once inserted into the charger.

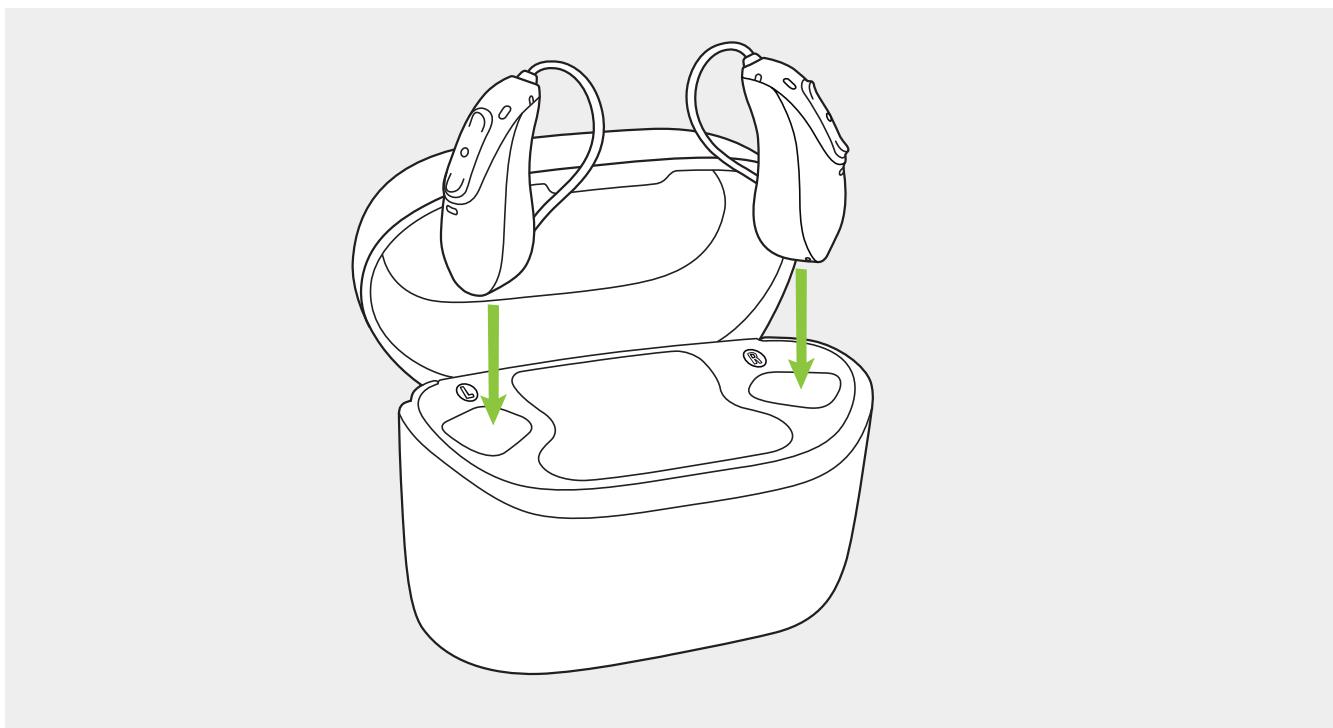





2.

The indicator light on the hearing aid will show the charging state of the battery until the hearing aid is fully charged. When fully charged the indicator light will remain on, i.e. solid green light.

The charging process will automatically stop when the batteries are fully charged, so the hearing aids can be safely left in the charger. It can take up to 3 hours to charge the hearing aids. The charger lid can be closed while charging.

Charging times

Indicator light	Charging state	Approx. charging times
	0 – 10%	
	11 – 80%	30 min (30%) 60 min (50%) 90 min (80%)
	81 – 99%	
	100%	3 h

3.

Remove the hearing aids from the charging slots by simply lifting them out of the charger.

The hearing aid can be set to switch on automatically when removed from the charger. The indicator light starts blinking. The solid green light indicates the hearing aid is ready for use.

If you unplug the charger while the hearing aid is charging inside, please make sure to turn off the hearing aid to prevent discharge. To switch off the charger, remove the power supply from the power outlet.

- ① Turn off your hearing aid before inserting it in the disconnected charger to store it.
- ① Do not hold the tubes to remove the hearing aids from the charger as this can damage the tubes.

5. Left and right hearing aid markings

There is a red or blue marking on the back of the hearing aid and on the speaker. This will tell you if it is a left or a right hearing aid.

Blue marking
for **left hearing aid**.

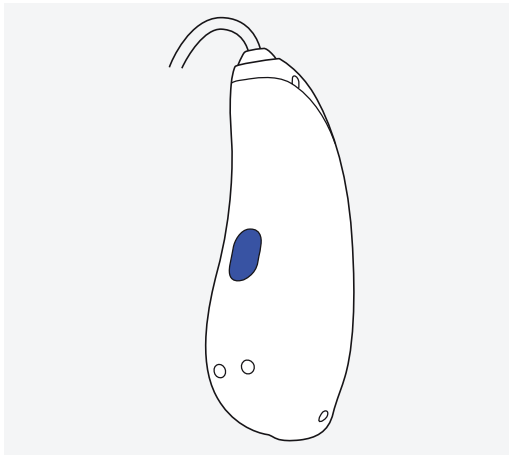

Red marking
for **right hearing aid**.

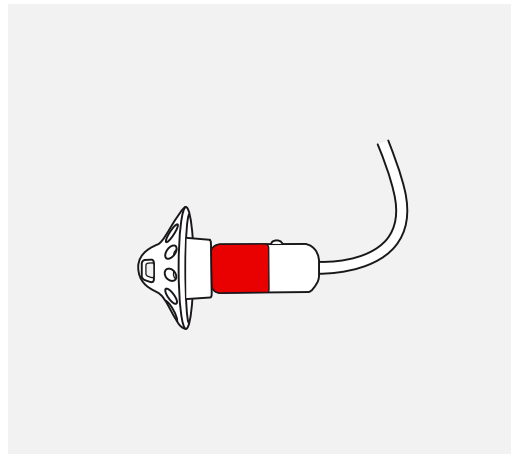
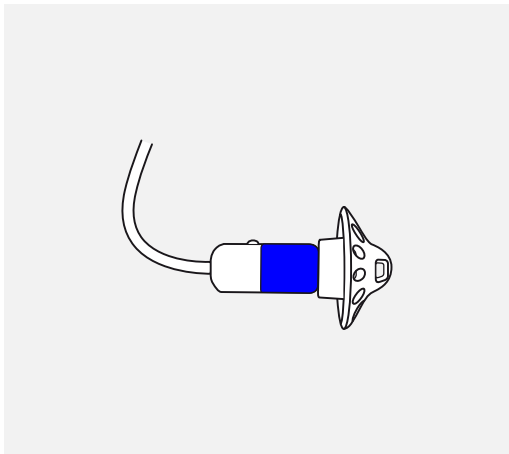
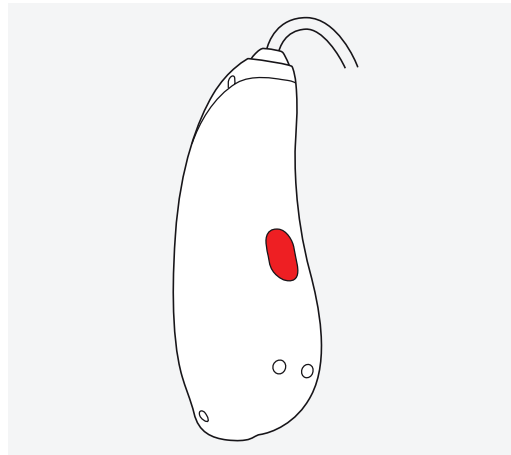

6. Putting on the hearing aid

1.

Place the hearing aid behind your ear.

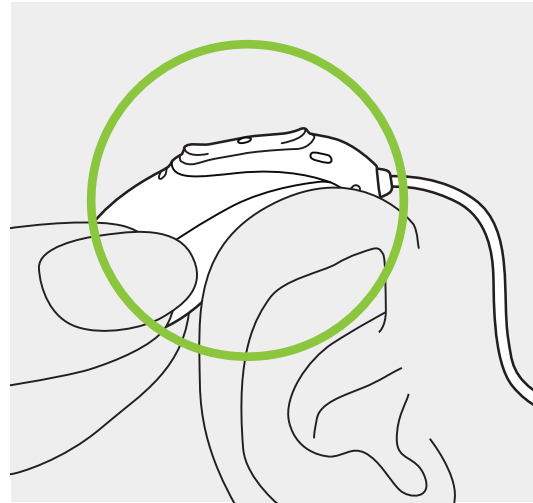

2.

Insert the earpiece into your ear canal.

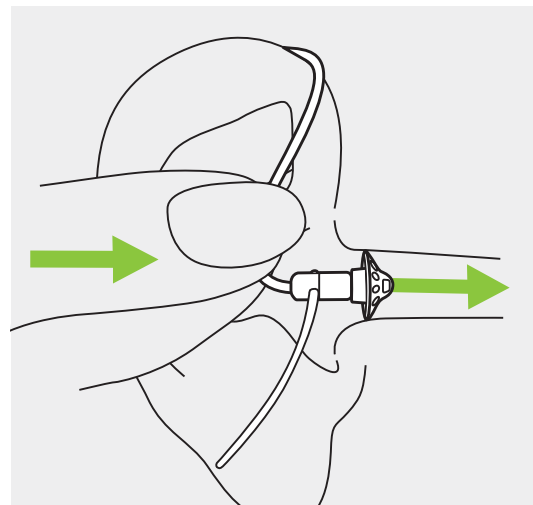

3.

If there is an anchor attached to the earpiece, tuck it into the bowl of your ear to secure your hearing aid.

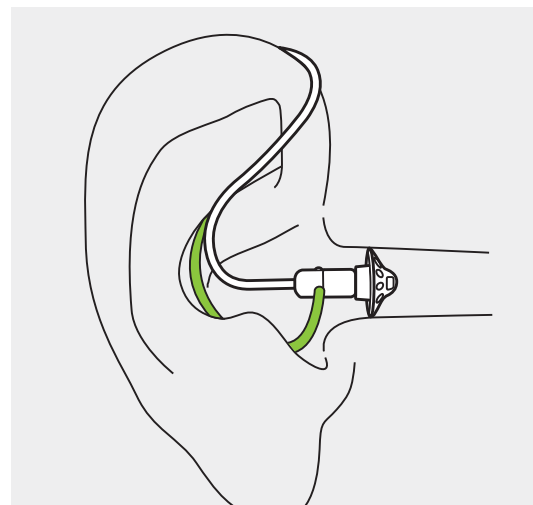

7. Removing the hearing aid

Pull on the bend of the tube and remove the hearing aid from behind the ear.

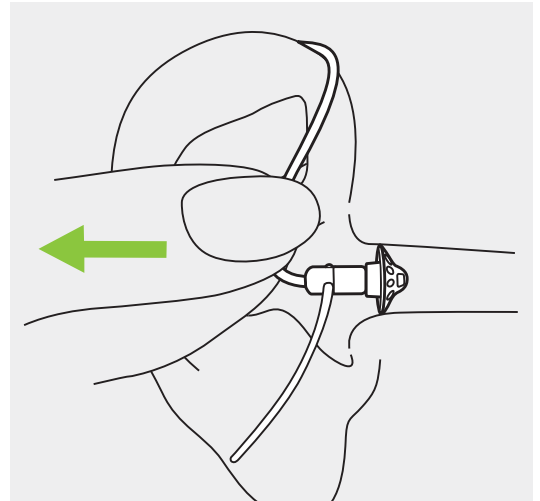

8. Multi-function button

The button has several functions, the primary function is as an on/off switch. Together with your hearing care professional, you can decide if it also allows for volume control and/or program change. This is indicated in your individual "Hearing aid instructions". Please ask your hearing care professional for a printout.

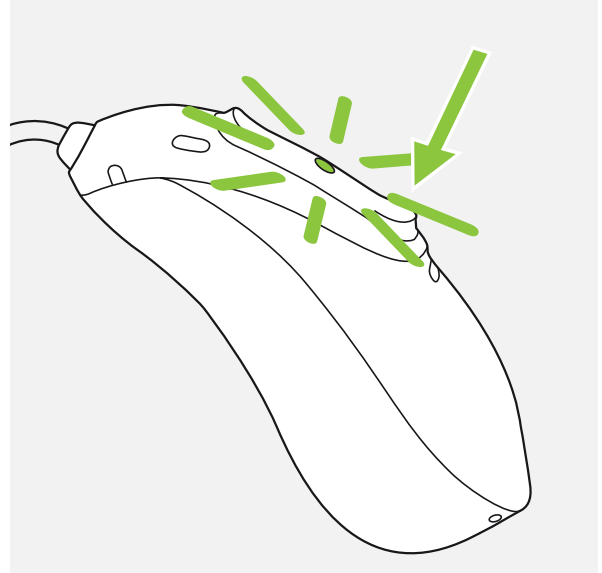

If the hearing aid is paired with a Bluetooth® enabled phone, a short press on the upper or the lower part of the button will accept an incoming call and a long press will reject an incoming call – refer to chapter 13.

9. On/Off

Switch on hearing aid

The hearing aid is configured to switch on automatically when removed from the charger. If this function is not configured, firmly press and hold the lower part of the button for 3 seconds until the indicator light blinks. Wait until the solid green light indicates the hearing aid is ready.

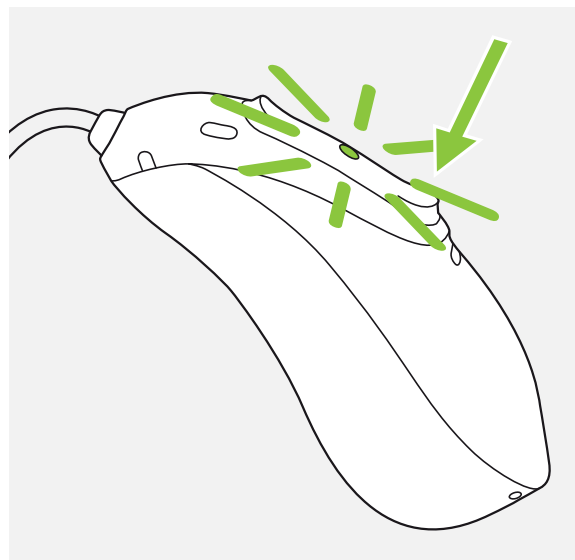

Switch off hearing aid

Press and hold the lower part of button for 3 seconds until the solid red light indicates the hearing aid is switching off.

	Blinking green	Hearing aid is switching on
	Solid red for 2 seconds	Hearing aid is switching off

i When you switch on the hearing aid you might hear a start-up melody.

10. Tap Control

Tap Control is only available for models L90 and L70. If paired with a Bluetooth® enabled device, multiple functions can be accessed using Tap Control e.g. accept/end phone call, pause/resume streaming, start/stop voice assistant. This is indicated in your individual "Hearing aid instructions".

To use Tap Control tap the top of your ear twice.



11. Connectivity overview

The illustration below shows the connectivity options available for your hearing aid.

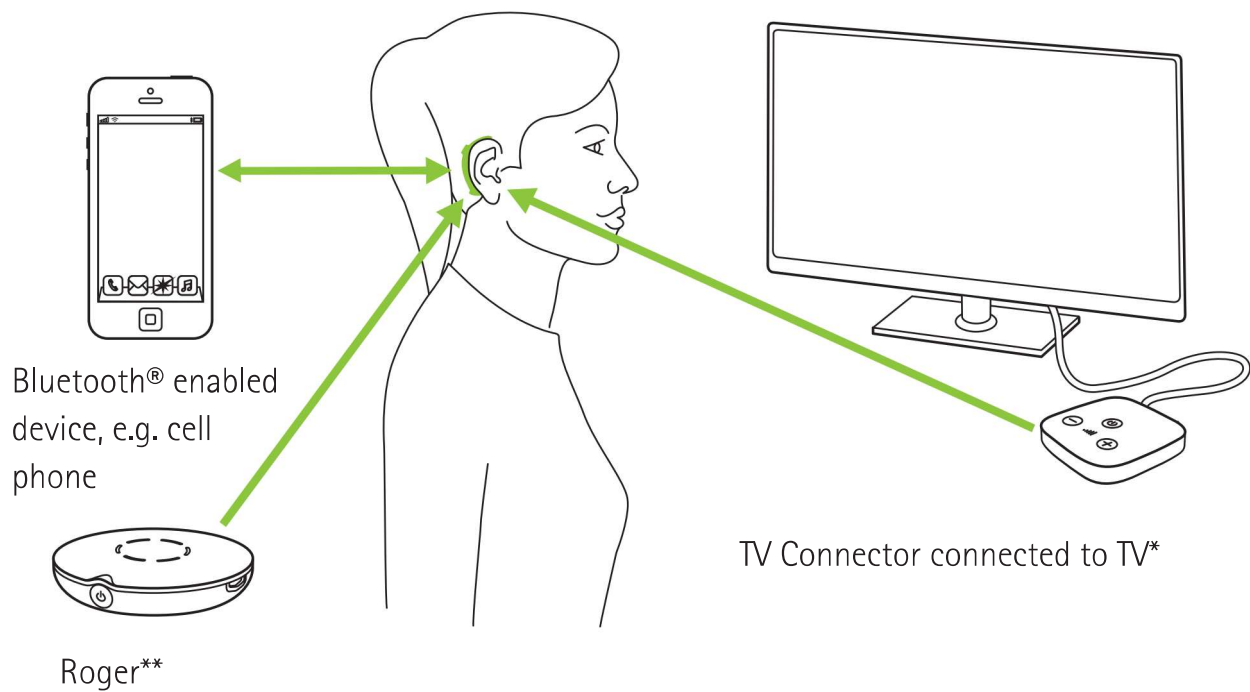

* The TV Connector can be connected to any audio source such as a TV, PC or hi-fi system.

** Roger wireless microphones can be connected to your hearing aids as well.

12. Initial pairing

12.1 Initial pairing to a Bluetooth® enabled device

① It is only necessary to perform the pairing procedure once with each device featuring Bluetooth wireless technology. After the initial pairing, your hearing aids will connect automatically to the device. Initial pairing can take up to 2 minutes.

1.

On your device (e.g. a phone), ensure that Bluetooth® wireless technology is enabled and search for Bluetooth® enabled devices in the connectivity setting menu.

2.

Switch on both hearing aids. You now have 3 minutes to pair your hearing aids with your device.

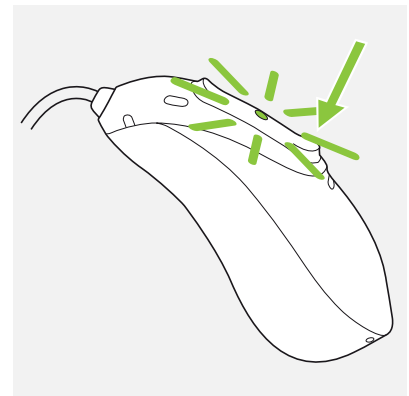

3.

Your device shows a list of Bluetooth® enabled devices. Select the hearing aid from the list to simultaneously pair both hearing aids. A beep confirms successful pairing.

- ① For more information about pairing instructions for Bluetooth wireless technology, specific to some of the most popular phone manufacturers, go to: <https://www.phonak.com/com/en/support.html>

12.2 Connecting to the device

After your hearing aids have been paired to your device, they will automatically connect again when switched on.

- ① The connection will be maintained as long as the device remains ON and within range.
- ① Your hearing aid can be connected to up to two devices and paired to up to eight devices.

13. Phone calls

Your hearing aids connect directly with Bluetooth® enabled phones. When paired and connected to your phone, you will hear notifications, incoming call notification and the caller's voice directly in your hearing aids. Phone calls are "hands free", this means your voice is picked up by the hearing aid's microphones and transmitted back to the phone.

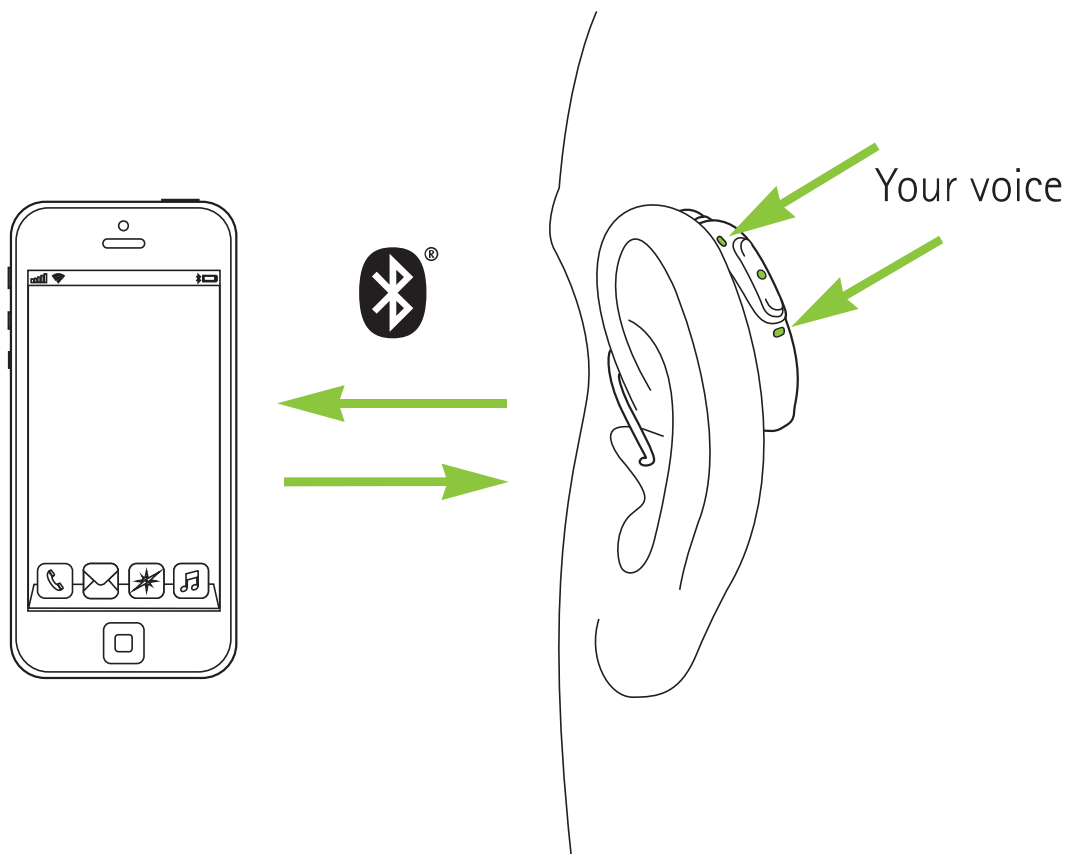

13.1 Making a call

Enter the phone number and press the dial button. You will hear the dialing tone through your hearing aids. Your voice is picked up by the hearing aid microphones and transmitted to the phone.

13.2 Accepting a call

When receiving a call, in-coming call notification will be heard in the hearing aids (e.g. ring tone or voice notification).

The call can be accepted by tapping the top of your ear twice (only available for models L90 and L70), a short press on the upper or lower part of the multi-function button on the hearing aid (less than 2 seconds) or directly on your phone.

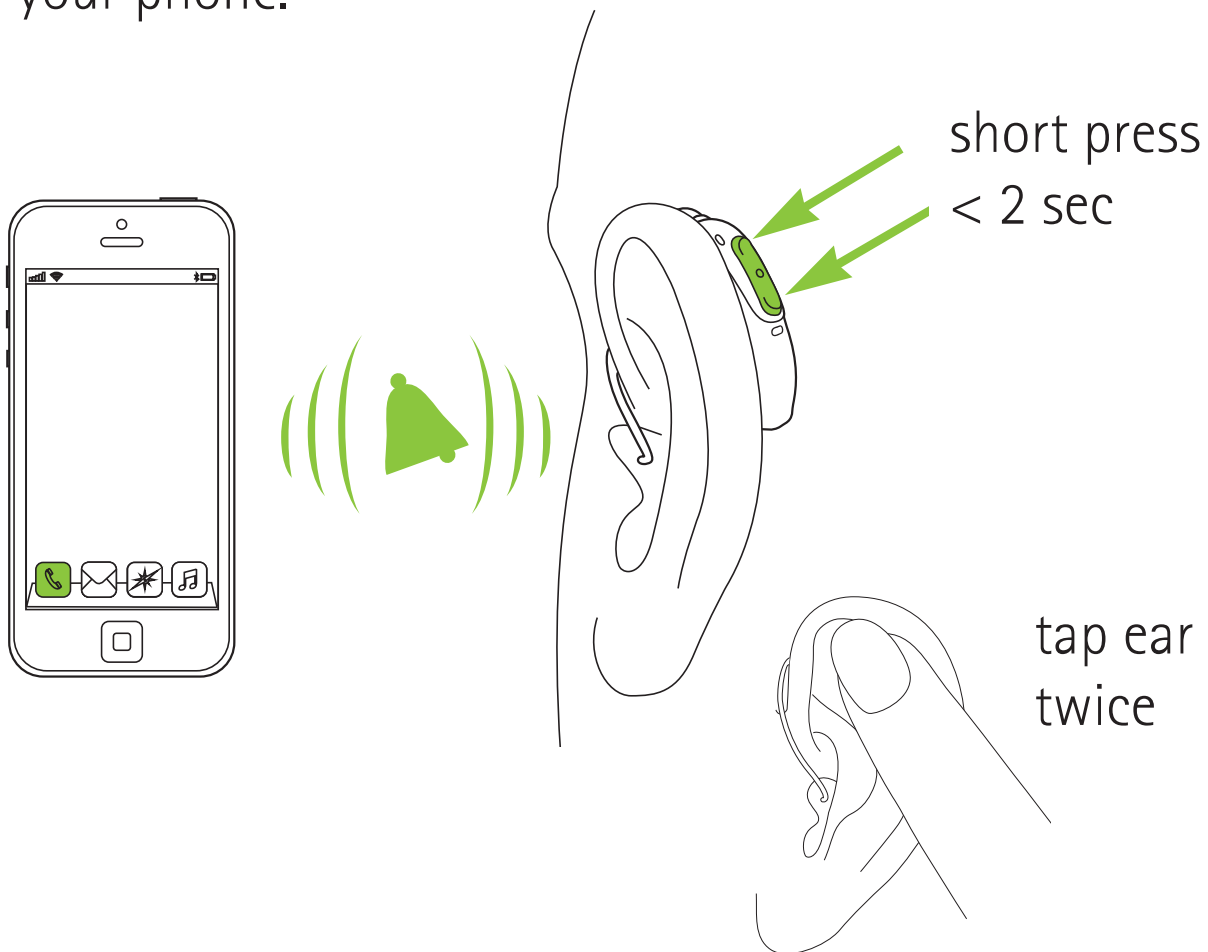

13.3 Ending a call

A call can be ended by a long press on the upper or lower part of the multi-function button on the hearing aid (more than 2 seconds) or directly on your phone. For models 90 and 70, the phone call can also be ended by tapping the top of your ear twice.

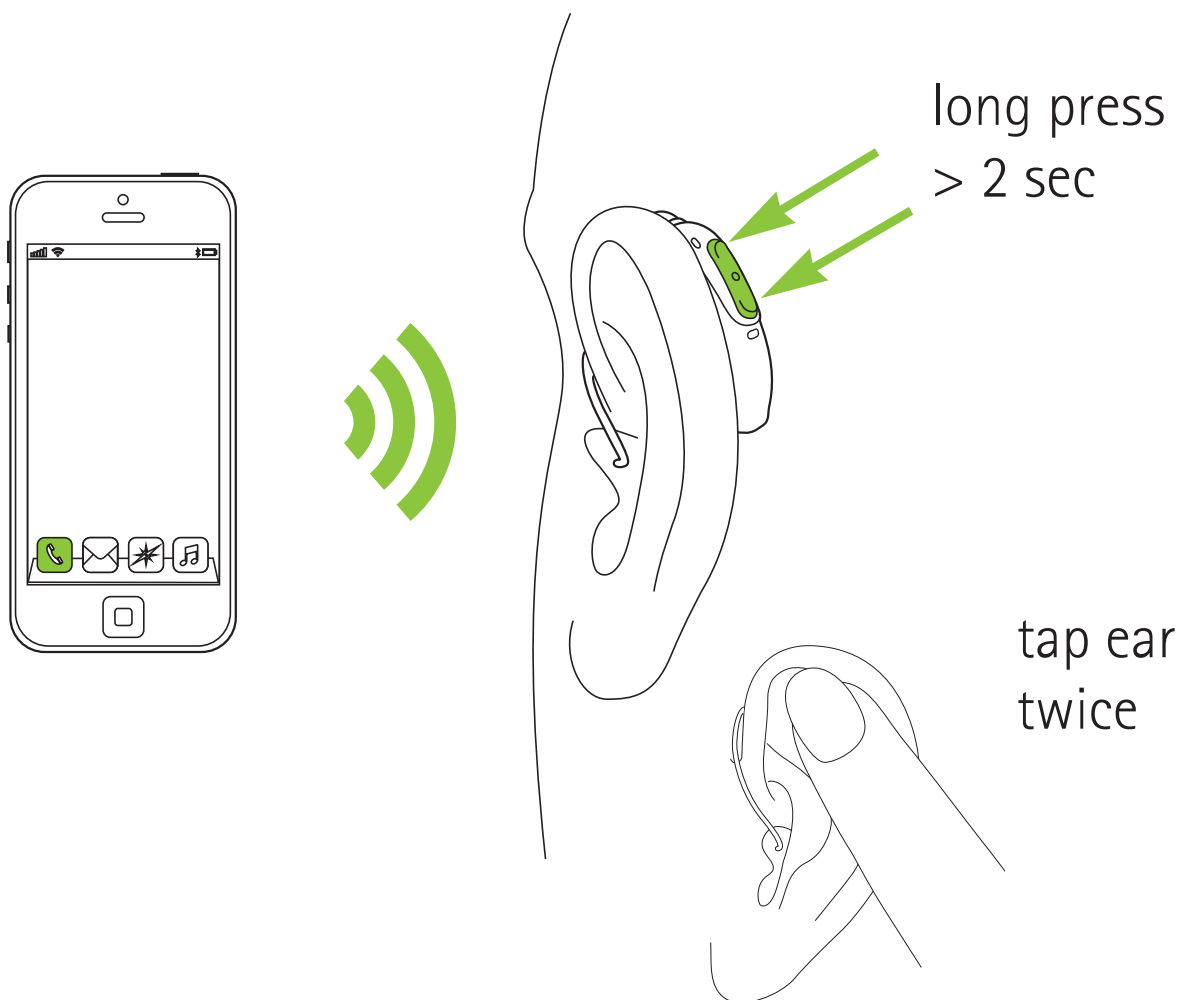

13.4 Rejecting a call

An incoming call can be rejected by a long press on the upper or lower part of the multi-function button on the hearing aid (more than 2 seconds) or directly on your phone.

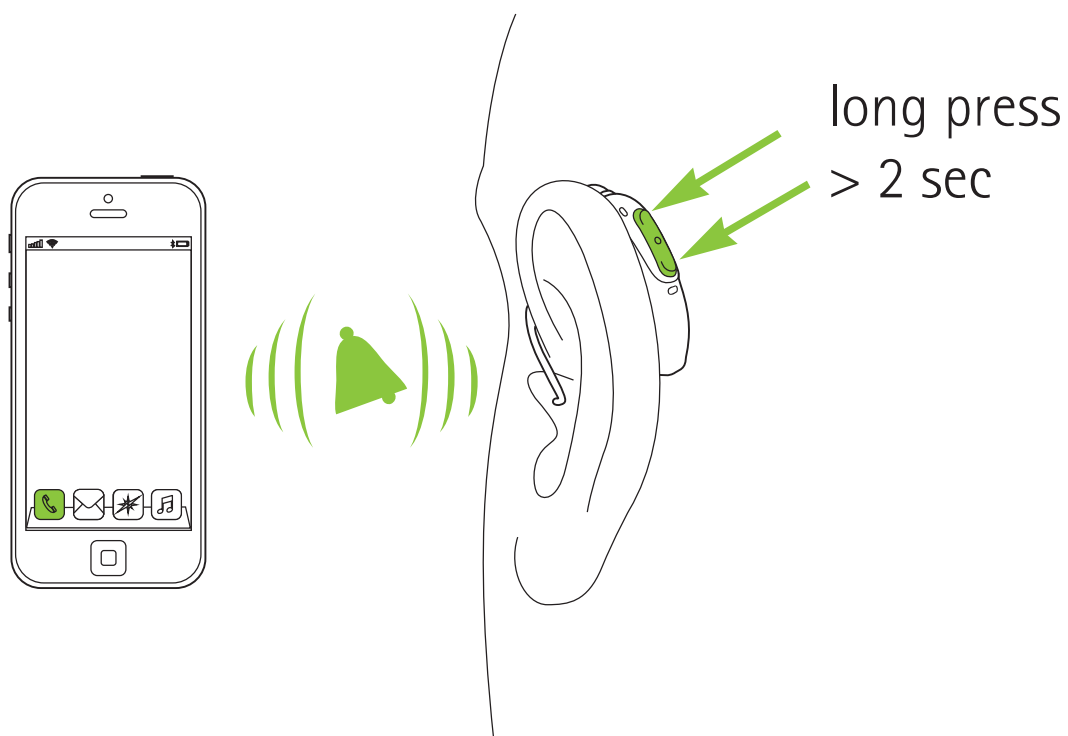







14. Flight mode

Your hearing aids operate between 2.4 GHz–2.48 GHz frequency range. When flying some operators require all devices to be switched into flight mode. Entering flight mode will not disable normal hearing aid functionality, only the Bluetooth connectivity functions.

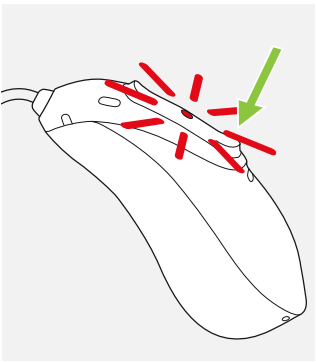
14.1 Enter flight mode

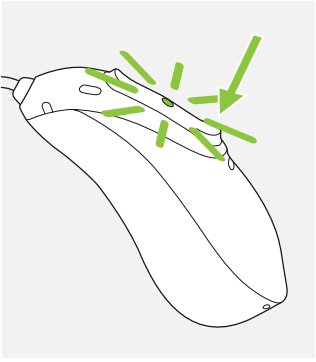
To disable the wireless function and enter flight mode in each hearing aid:

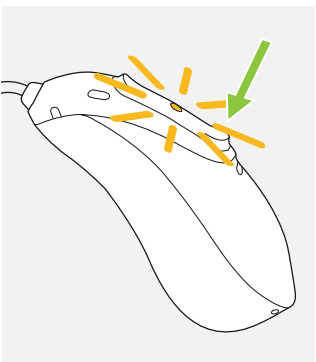
1.		<p>If the hearing aid is turned off, proceed to Step 2.</p> <p>If the hearing aid is on, turn it off by pressing and holding the lower part of the button for 3 seconds, until the indicator light turns solid red for 3 seconds, signifying that the hearing aid is switching off.</p>	
2.		<p>Press and hold the lower part of the button. The green indicator light blinks when the hearing aid starts up.</p>	
3.		<p>Keep pressing the button for 7 seconds, until the indicator light is solid orange, then release the button.</p> <p>The solid orange light indicates the hearing aid is in flight mode.</p>	

In flight mode, your hearing aid cannot connect directly to your phone.

14.2 Exit flight mode

To enable the wireless function and exit flight mode in each hearing aid:

Switch the hearing aid off and then on again - refer to chapter 9.

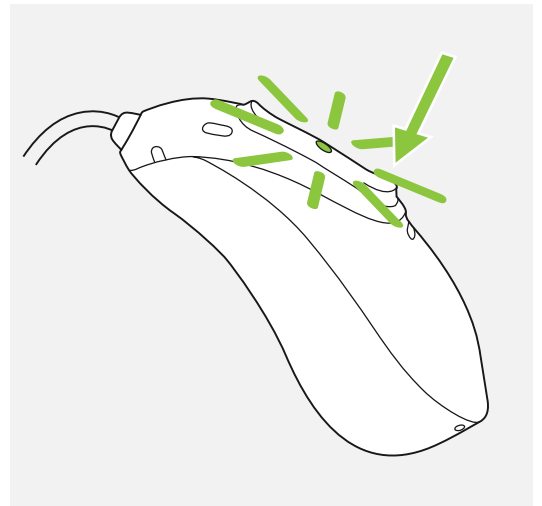

15. Rebooting your hearing aid

Use this technique if your hearing aid is in an error state. This will not remove or delete any program or settings.

1.

Press the lower part of the multi-function button for at least 15 seconds. It does not matter if the hearing aid is switched on or off before you start pressing the button. There is no light or acoustic notification at the end of the 15 seconds.

2.

Place the hearing aid in the power-connected charger and wait until the indicator light blinks green. This can take up to 30 seconds. The hearing aid is now ready to use.

16. myPhonak App overview

Please find the Instruction for Use on
www.phonak.com/myphonakapp.
or scan the code



Install myPhonak, app for users of iPhone
devices



Install myPhonak app for users of
smartphones operating under Android OS



iPhone® is a trademark of Apple Inc., registered in the U.S. and other countries.

iOS® is a registered trademark or trademark of Cisco Systems, Inc. and/or its affiliates in the United States and certain other countries.

Android™ is a trademark of Google LLC.

17. Roger™ overview

Experience the hearing performance of Roger™

Roger™ is designed to improve hearing in situations with background noise or distance to the speaker. The microphone picks up the voice of the speaker and wirelessly transmits it directly to Roger receivers* in your hearing aids**. This enables you to fully participate in group conversations even in very noisy environments such as restaurants, meetings at work and school activities.

To learn more about the Roger technology and microphones, please visit the webpage <https://www.phonak.com/roger-solutions> or scan the QR code



* RogerDirect™ requires the installation of Roger receivers into the Phonak hearing aids by a hearing care professional.

** Audéo L20-R is not compatible with Roger products

18. Listening in public places (Optional)

Your hearing aids may have a telecoil option that can help you hear in various public places such as church, concert hall, train station and government buildings.

When you see this symbol, a loop system is present and is compatible with your hearing aids. Please contact your hearing care professional for further information and activation of the telecoil function.



How to use your telecoil function

Accessing the telecoil function that your hearing care professional has set up is possible two ways. Direct access to the telecoil program is possible via a long press of the push button on your hearing aid. Alternatively it is possible to access the telecoil program via the myPhonak app. Ensure you are standing or seated within the designated loop system area as noted by the official telecoil symbol.

19. Operating, transport and storage conditions

The product is designed such that it functions without problems or restrictions if used as intended, unless otherwise noted in these user guides.

Please ensure to use, charge, transport and store the hearing aids and the charger according to the following conditions:

Audéo L R/RT and Charger

	Use	Charging	Transport	Storage
Temperature				
Maximum range	+5° to +40°C (41° to 104°F)	5° to +40°C (41° to 104°F)	-20° to +60°C (-4° to 140°F)	-20° to +60°C (-4° to 140°F)
Recommended range	+5° to +40°C (41° to 104°F)	+7° to +32°C (45° to 90°F)	0° to +20°C (32° to 68°F)	0° to +20°C (32° to 68°F)
Humidity				
Maximum range	0% to 85% (non condensing)	0% to 85% (non condensing)	0% to 70%	0% to 70%
Recommended range	0% to 60% (non condensing)	0% to 60% (non condensing)	0% to 60%	0% to 60%
Atmospheric pressure	500 hPa to 1060 hPa	500 hPa to 1060 hPa	500 hPa to 1060 hPa	500 hPa to 1060 hPa

These hearing aids are classified as IP68. This means that they are water and dust resistant and designed to withstand daily life situations. They can be worn in the rain but should not be fully submerged in water or used when taking a shower, swimming or other water activities. These hearing aids should never be exposed to chlorinated water, soap, salt water or other liquids with a chemical content.

This charger is classified as IP21. This means that the charger is protected from vertically falling drops of water e.g. condensation.

Please ensure to charge the hearing aids regularly during long-term storage.

If the device has been subject to storage and transport conditions outside of the recommended use conditions, wait 15 minutes before starting the device.

20. Care and maintenance

Expected Service Life:

The hearing aids and the compatible charger have the expected service life of five years. The devices are expected to remain safe for use for this duration.

Commercial service period:

Routine and diligent care of your hearing aids and charger will contribute to the outstanding performance for the duration of the expected service life of your devices.

Sonova AG will provide a minimum of a five year repair service period after the respective hearing aid, charger and essential components have been phased out of the product portfolio.

Please use the following specifications as a guideline. For further information regarding product safety, see chapter 26.2.

General information

Before using hair spray or applying cosmetics, you should remove your hearing aid from your ear, because these products may damage it.

Your hearing aids are resistant to water, sweat and dust under the following conditions:

- After exposure to water, sweat or dust, the hearing aid is cleaned and dried.
- The hearing aid is used and maintained as described in this user guide.



Always make sure that the hearing aids and charger are dry and clean before charging.

Daily

Hearing aid: Inspect the earpiece for earwax and moisture deposit and clean the surfaces with a lint-free cloth. Never use cleaning agents such as household detergents, soap, etc. for cleaning your hearing aid. It is not recommended to rinse with water. If you need to clean your hearing aid intensively, ask your hearing care professional for advice and information on filters or drying methods.

Charger: Make sure that charger inserts are clean and clean the surfaces with a lint-free cloth.

Never use cleaning agents such as household detergents, soap, etc. for cleaning your charger.

Weekly

Hearing aid: Clean the earpiece with a soft, damp cloth or with a special cleaning cloth for hearing aids. For more in-depth maintenance instructions, please see your hearing care professional. Clean the charging contacts on the hearing aid with a soft, damp cloth.

Chargers: Remove dust or dirt from the charger inserts with a lint-free cloth.



Always make sure that the charger is disconnected from the power mains before cleaning.

21. Exchanging the earwax protection

Your hearing aid is equipped with an earwax protection to protect the speaker from earwax damage.

Please check the earwax protector regularly and exchange it if it looks dirty or if the hearing aid volume or sound quality is reduced. The earwax protection should be replaced every four to eight weeks on a regular receiver, and once a week on the ActiveVent™ receiver.

21.1 Regular receiver with dome

21.1.1 Removing the earpiece from the speaker

1.

Remove the earpiece from the speaker by holding the speaker in one hand and the earpiece in the other.

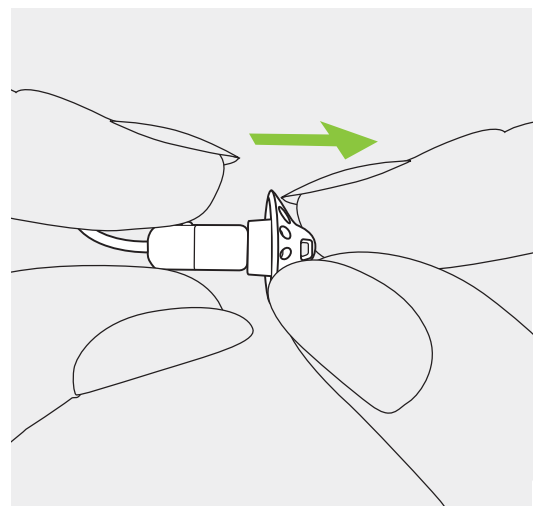

2.

Gently pull off the earpiece to remove.

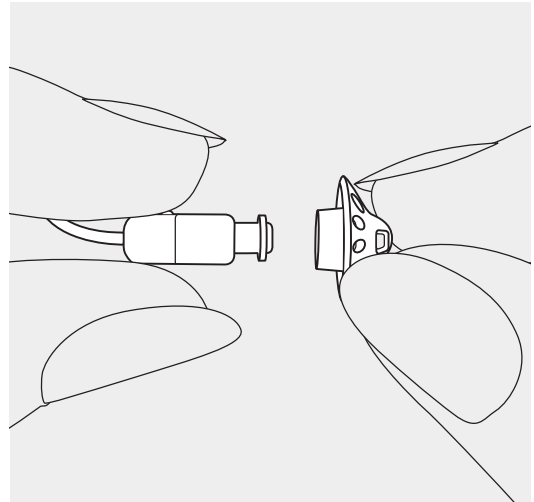

3.

Clean the speaker with a lint-free cloth.

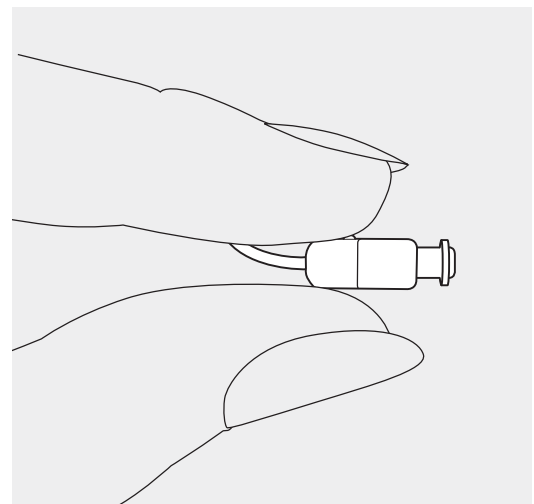

21.1.2 Exchanging the earwax protection with CeruShield™ Disk

1.

Gently rotate the CeruShield Disk in the direction indicated by the arrows until a free opening appears under the bin icon.

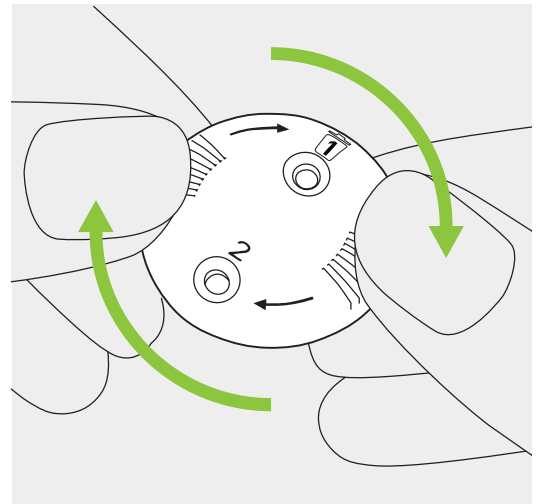

2.

To remove a used earwax protector carefully insert the speaker into the free opening (under bin icon) until it clicks. The used earwax protector will remain in the disk when you lift the speaker away.

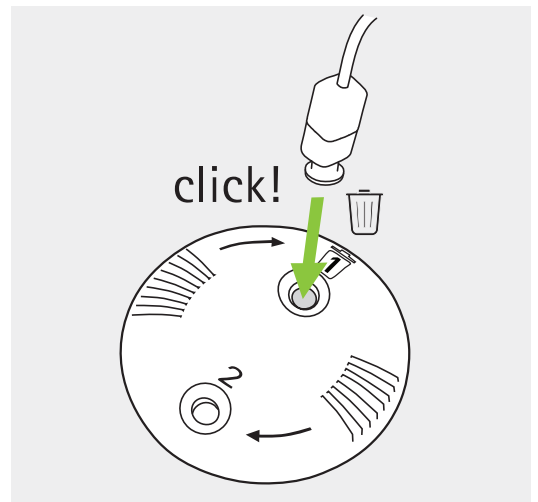

3.

To insert a new earwax protector carefully insert the speaker into the opening where the new earwax protector is visible (opposite the bin icon) until it clicks. Lift the speaker away from the disk, the new earwax protector is now positioned inside the speaker.

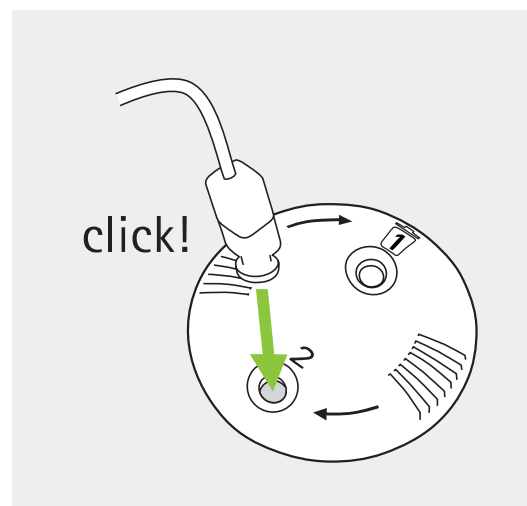

21.1.3 Attaching the earpiece to the speaker

1.

Hold the speaker in one hand and the earpiece in the other.

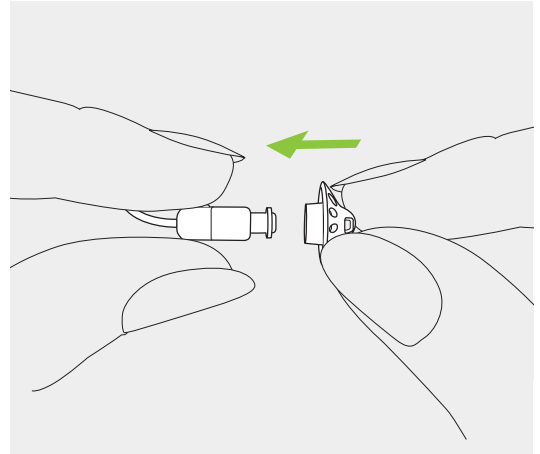

2.

Slide the earpiece over the speaker sound outlet.

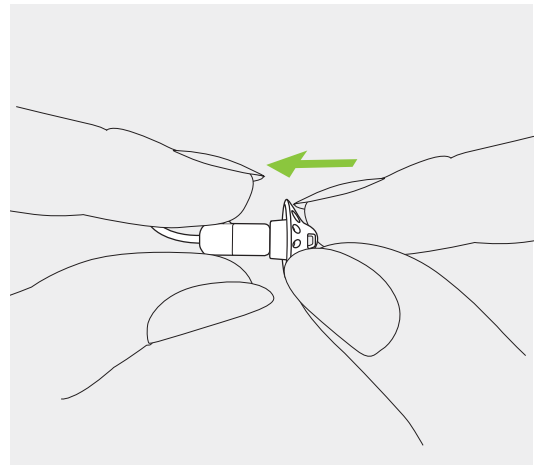

3.

The speaker and the earpiece should fit perfectly together.

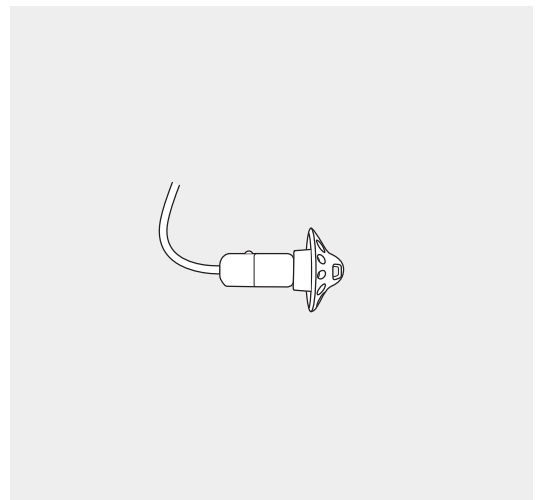

21.2 ActiveVent™ receiver with SlimTip

21.2.1 Parts Explanation

1. Wax filter dispenser

a) rotating disk

b) new filter

c) dispensing slot for used filters

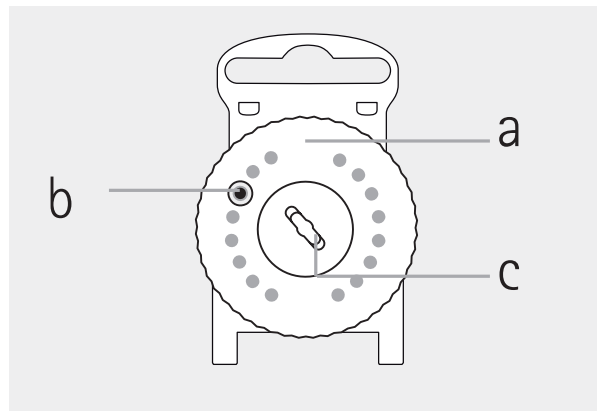

2. Changing tool

a) screw end
for removing used filter

b) forked end
for inserting new filter

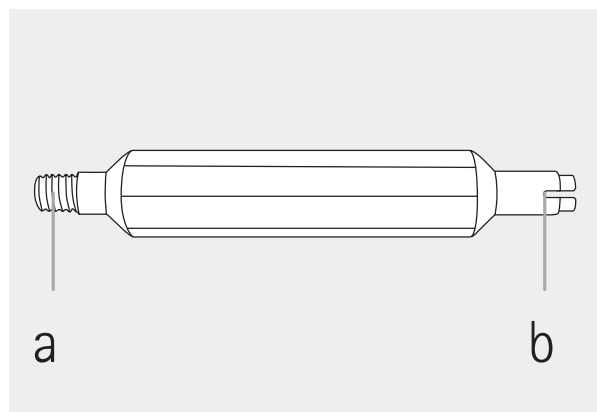

21.2.2 Removing the used wax filter (HF3 Filter)

1.

Hold the earpiece firmly and secure the rear of the speaker with your finger.

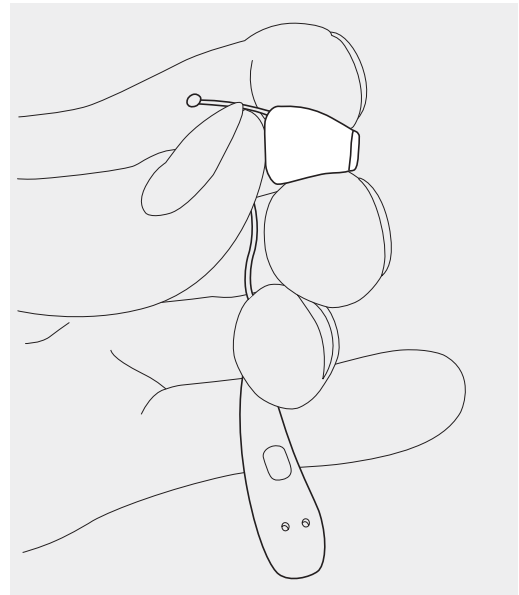

2.

Insert the screw end of the HF-3 changing tool into the speaker of the hearing aid.

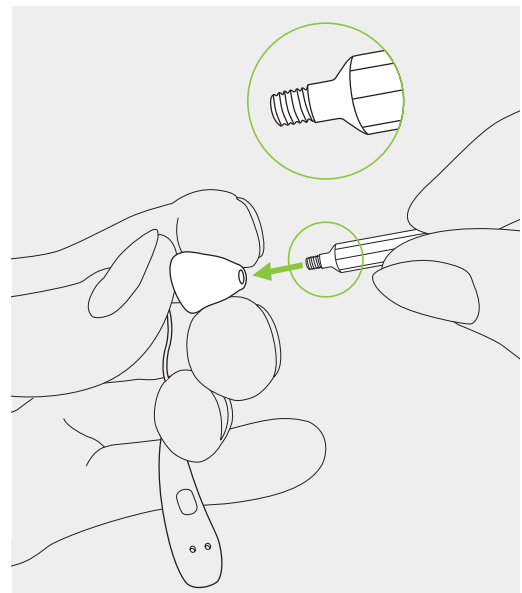

3.

Rotate the changing tool clock-wise until some resistance is felt.

Pull the changing tool out of the speaker with the used wax filter attached to the end.

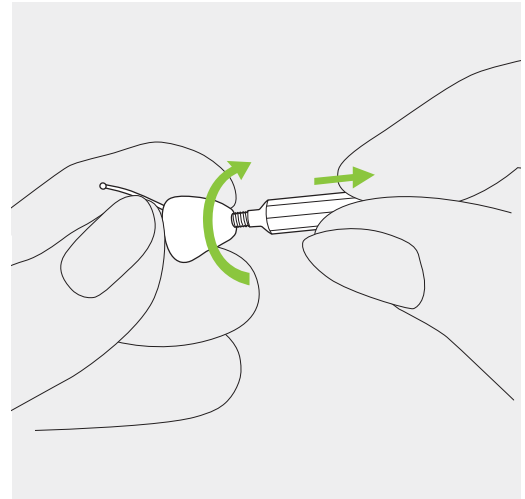

4.

Insert the used wax filter into the dispensing slot in the middle of the wax filter dispenser.

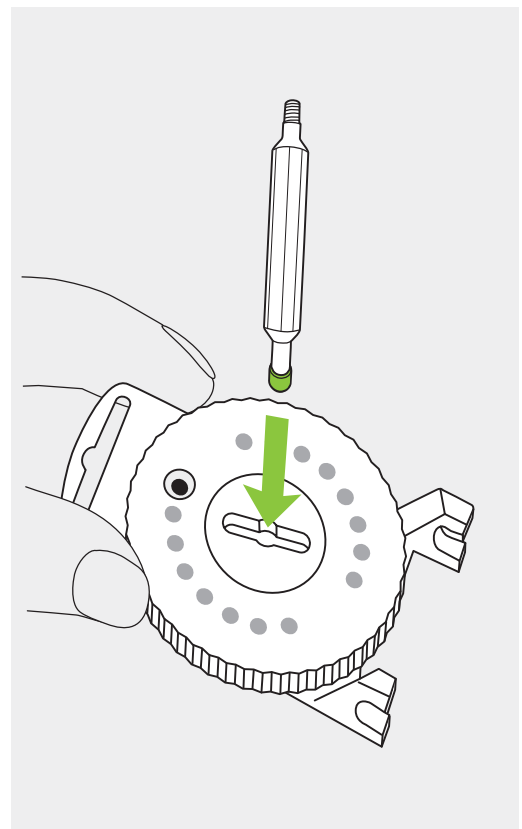

5.

Slide the changing tool to either side of the dispensing slot. Lift the changing tool up, leaving the used wax filter in dispensing slot.

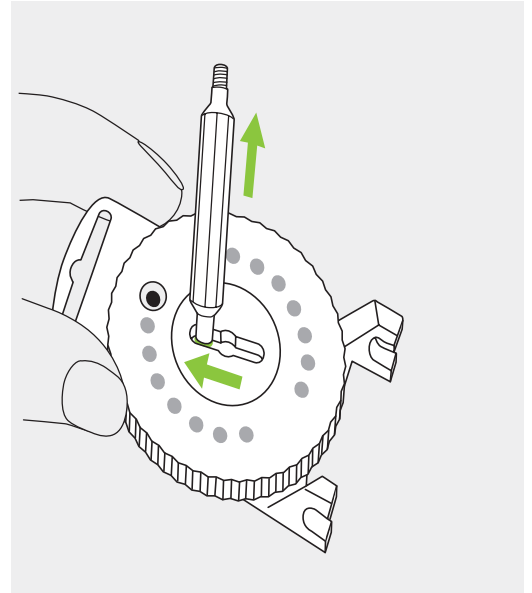

21.2.3 Inserting a new wax filter

1.

After removing the used wax filter from the speaker of the hearing aid, brush away any remaining debris.

Rotate the ridged disk of the wax filter dispenser until a new wax filter is visible in the window of the disk.

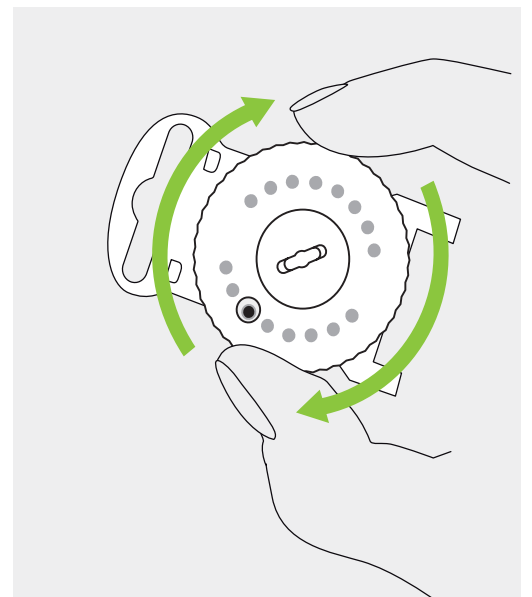

2.

Now use the opposite end of the changing tool (i.e. forked end) to pick up a new wax filter.

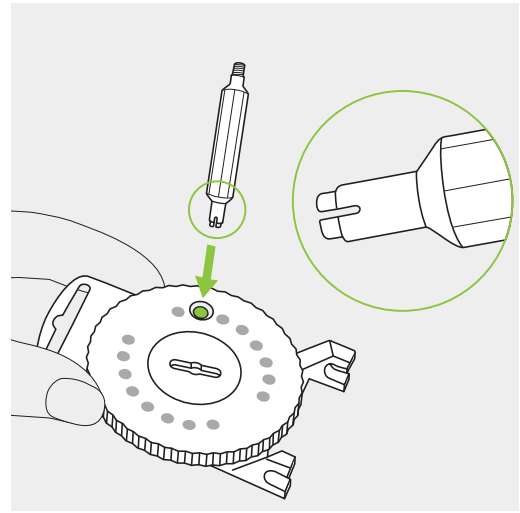

3.

Insert the forked end of the changing tool down and pull up

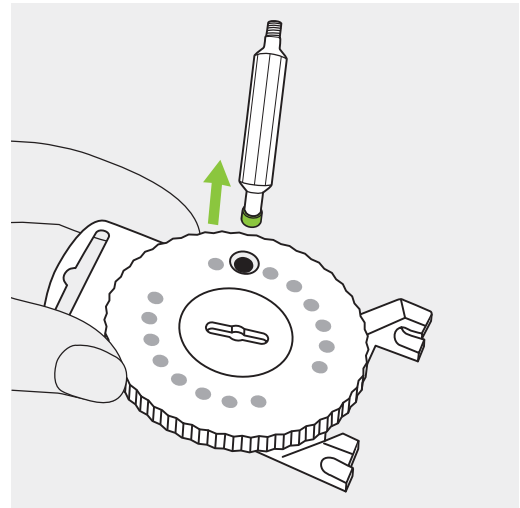

4.

Insert the new wax filter into the speaker of the hearing aid.

Make sure to secure the rear of speaker with your finger.

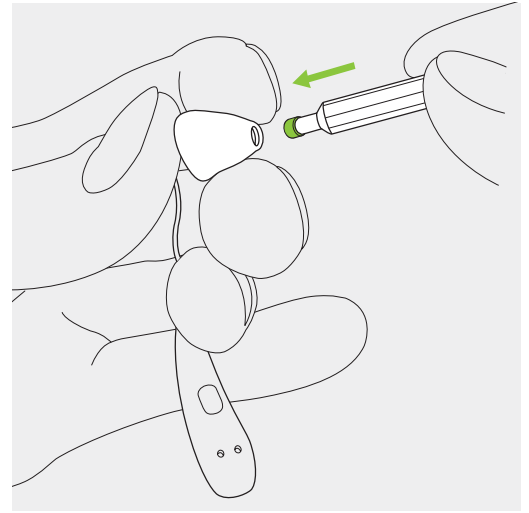

5.

Once the new filter is securely placed in the speaker, lift the changing tool away tilted in a slight angle.

Reattach the changing tool to the wax filter dispenser

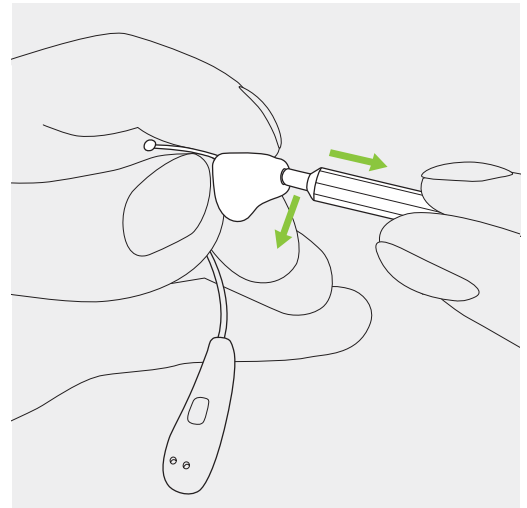

22. Service and warranty

Local warranty

Please ask the hearing care professional where you purchased your hearing aids and charger about the terms of the local warranty.

International warranty

Sonova AG offers a one year limited international warranty, valid from the date of purchase. This limited warranty covers manufacturing and material defects in the hearing aid and charger respectively, but not accessories such as tubes, earpieces, external receivers. The warranty only comes into force if a proof of purchase is shown.

The international warranty does not affect any legal rights that you might have under applicable national legislation governing sale of consumer goods.

Warranty limitation

This warranty does not cover damage from improper handling or care, exposure to chemicals or undue stress. Damage caused by third parties or non-authorized service centers renders the warranty null and void. This warranty does not include any services performed by a hearing care professional in their office.

Serial numbers

Hearing aid left side: _____

Hearing aid right side: _____

Charger: _____

Date of purchase: _____

Authorized hearing care professional
(stamp/signature):

23. Compliance information

Europe:

Declaration of Conformity for the hearing aid

Hereby Sonova AG declares that this product meets the requirements of the Medical Device Regulation (EU) 2017/745 as well as the Radio Equipment Directive 2014/53/EU.

The full text of the EU Declaration of Conformity can be obtained from the manufacturer or the local Phonak representative whose address can be taken from the list on www.phonak.com/us/en/certificates (Phonak worldwide locations).

Australia/New Zealand:



R-NZ

Indicates a device's compliance with applicable Radio Spectrum Management's (RSM) and Australian Communications and Media Authority (ACMA) regulatory arrangements for the legal sale in New Zealand and Australia.

The compliance label R-NZ is for radio products supplied in the New Zealand market under conformity level A1.

The wireless models listed on page 2 are certified under:

Phonak Audéo L-R (90/70/50/30/20)

Phonak Audéo L-RT (90/70/50/30)

Phonak Audéo L-R/RT Trial

USA

FCC ID: KWC-MRP

Canada

IC: 2262A-MRP

Notice 1:

This device complies with Part 15 of the FCC Rules and with RSS-210 of Industry Canada. Operation is subject to the following two conditions:

- 1) this device may not cause harmful interference, and
- 2) this device must accept any interference received, including interference that may cause undesired operation.

Notice 2:

Changes or modifications made to this device not expressly approved by Sonova AG may void the FCC authorization to operate this device.

Notice 3:

This device has been tested and found to comply with the limits for a Class B digital device, pursuant to Part 15 of the FCC Rules and ICES-003 of Industry Canada.

These limits are designed to provide reasonable protection against harmful interference in a residential installation.

This device generates, uses and can radiate radio frequency energy and, if not installed and used in accordance with the instructions, may cause harmful interference to radio communications. However, there is

no guarantee that interference will not occur in a particular installation. If this device does cause harmful interference to radio or television reception, which can be determined by turning the equipment off and on, the user is encouraged to try to correct the interference by one or more of the following measures:

- Reorient or relocate the receiving antenna.
- Increase the separation between the device and receiver.
- Connect the device into an outlet on a circuit different from that to which the receiver is connected.
- Consult the dealer or an experienced radio/TV technician for help.

Radio information of your wireless hearing aid

Antenna type	Resonant loop antenna
Operation frequency	2.4 GHz – 2.48 GHz
Modulation	GFSK, Pi/4 DPSK, GMSK
Radiated power	< 2.5 mW

Bluetooth®

Range	~1 m
Bluetooth	4.2 Dual-Mode
Profiles supported	HFP (Hands-free profile), A2DP

Emissions Test Compliance Electromagnetic environment guidance

RF emissions CISPR 11	Group 2 Class B	The medical device uses RF energy only for its internal function. Therefore, its RF emission are very low and are not likely to cause any interferences in nearby electronic equipment
Harmonic emissions	Complies	
Voltage fluctuations / flicker emissions	Complies	

Compliance with emission and immunity standards

Emission standards	EN 60601-1-2
	IEC 60601-1-2
	EN 55011
	CISPR11
	CISPR32
	CISPR25
	EN 55025

Immunity standards	EN 60601-1-2
	IEC 60601-1-2
	EN 61000-4-2
	IEC 61000-4-2
	EN IEC 61000-4-3
	IEC 61000-4-3
	EN 61000-4-4
	IEC 61000-4-4
	EN 61000-4-5
	IEC 61000-4-5
	EN 61000-4-6
	IEC 61000-4-6
	EN 61000-4-8
	IEC 61000-4-8
	EN 61000-4-11
	IEC 61000-4-11
	IEC 60601-1
	ISO 7637-2

24. Information and description of symbols



With the CE symbol, Sonova AG confirms that this product – including accessories – meets the requirements of the Medical Devices Regulation (EU) 2017/745 as well as the Radio Equipment Directive 2014/53/EU. The numbers after the CE symbol correspond to the code of certified institutions that were consulted under the above-mentioned regulation and directive.



This symbol indicates that the products described in these user instructions adhere to the requirements for an applied part of Type B of EN 60601-1. The surface of the hearing aid is specified as an applied part of Type B.



Indicates the medical device manufacturer, as defined in Medical Device Regulation (EU) 2017/745.



Indicates the date when the medical device was manufactured



Indicates the Authorized representative in the European Community. The EC REP is also the importer to the European Union.



This symbol indicates that it is important for the user to read and take into account the relevant information in these user guides.



This symbol indicates that it is important for the user to pay attention to the relevant warning notices in these user guides.



This symbol indicates that it is important for the user to pay attention to the relevant warning notices related to batteries in these user guides



Important information for handling and product safety.



This symbol confers that the electromagnetic interference from the device is under limits approved by the US Federal Communications Commission.



Indicates a device's compliance with applicable Radio Spectrum Management's (RSM) and Australian Communications and Media Authority (ACMA) regulatory arrangements for the legal sale in New Zealand and Australia



The Bluetooth® word mark and logos are registered trademarks owned by Bluetooth SIG, Inc. and any use of such marks by Sonova AG is under license. Other trademarks and trade names are those of their respective owners.

Segurança



The Compliance Identification Mark indicates that the device is in accordance with Brazilian conformity assessment requirements for equipment under health surveillance system. OCP indicates the certification body.



Japanese mark for certified radio equipment.



Indicates the manufacturer's serial number so that a specific medical device can be identified.



Indicates the manufacturer's catalogue number so that the medical device can be identified.



Indicates that the device is a medical device.



This symbol indicates that it is important for the user to read and take into account the relevant information in this user guide.

IP68

Ingress Protection Rating. IP68 rating indicates that the hearing aid is water and dust resistant. It survived continuous immersion in 1 meter of fresh water for 60 minutes and 8 hours in a dust chamber as per the IEC60529 standard.

IP21

IP Rating = Ingress Protection Rating. IP21 rating indicates that the device is protected against solid foreign objects of 12,5 mm 0 and greater. Protected against vertically falling water drops.



Temperature during transportation and storage: -20° to $+60^{\circ}$ Celsius (-4° to $+140^{\circ}$ Fahrenheit).



Humidity during transportation and storage: 0% to 70%, if not in use. See instruction in chapter 25.2 regarding drying the hearing aid after use.



Atmospheric pressure during operation transportation and storage: 500 hPa to 1060 hPa



During transportation keep dry.



The symbol with the crossed-out garbage bin is to make you aware that this hearing aid as well as the charger may not be thrown away as normal household waste. Please dispose of old or unused hearing aids and charger, at waste disposal sites intended for electronic waste, or give your hearing aid and charger to your hearing care professional for disposal. Proper disposal protects the environment and health

Symbols applicable to the European power supply only



Power supply with double isolation.



Device designed for indoor use only.



Safety isolating transformer, short circuit proof.

25. Troubleshooting

Problem	Causes
Hearing aid not functioning	Speaker/earpiece blocked Hearing aid switched off Battery fully discharged
Hearing aid whistles	Hearing aid not inserted correctly into ear Cerumen in ear canal
Hearing aid too loud	Volume too loud
Hearing aid not loud enough or distorted	Volume too low Low battery Speaker/earpiece blocked Hearing has changed
Hearing aid plays two beeps	Indication for low battery
Hearing aid will not switch on	Battery fully discharged Button was inadvertently deactivated by pressing the button longer than 15 seconds
Indicator light on hearing aid does not light up when hearing aid placed in charging slots	Hearing aid not inserted correctly into charger Hearing aid battery fully discharged

What to do

Clean speaker opening/earpiece

Press lower part of multi-function button for 3 seconds (chapter 9)

Charge hearing aid (chapter 4)

Insert hearing aid correctly (chapter 6)

Contact your ENT/GP or hearing care professional

Decrease volume if volume control available (chapter 8)

Increase volume if volume control available (chapter 8)

Charge hearing aid (chapter 4)

Clean speaker opening/earpiece

Contact your hearing care professional

Charge hearing aid (chapter 4)

Charge hearing aid (chapter 4)

Perform step 2 of the rebooting process (chapter 15)

Insert hearing aid correctly into charger (chapter 4)

Wait three hours after placing hearing aid in charger, regardless of LED behavior

Problem	Causes
Indicator light on hearing aid is solid red while hearing aid is in the charger	Hearing aid is out of its operating temperature range Faulty battery
Indicator light on hearing aid switches off when hearing aid is removed from charger	"Auto On" feature is disabled
Hearing aid with ActiveVent™ receiver is not working properly	Vent in wrong position (e.g. closed) Wax Other
ActiveVent™ receiver feels loose in earpiece or has separated completely from earpiece	Speaker dislodged from earpiece (i.e during exchange of earwax protection)
Indicator light on hearing aid remains solid green after removal from charger	Indicator light on hearing aid was red when hearing aid was placed into the charger
Battery does not last the whole day	Shortened battery life
Phone call function does not work	Hearing aid is in flight mode Hearing aid not paired to the phone

What to do

Warm hearing aid up or cool it down. Operating temperature range is +5° to +40° Celsius (+41° to +104° Fahrenheit)

Contact your hearing care professional

Switch on the hearing aid (chapter 9)

Reboot by switching hearing aid off and on again

Clean the speaker opening and / or change the wax filter (chapter 21.2)

Contact your hearing care professional

Push the speaker back into the earpiece.. If the speaker is still loose contact your hearing care professional.

Reboot the hearing aid (chapter 15)

Contact your hearing care professional. A battery replacement may be required

Switch hearing aid off and then on again (chapter 14.2)

Pair hearing aid to the phone (chapter 12)

Problem

Charging does not start (but indicator light around the charger USB port lights up green when the charger is connected to the power outlet.)

Causes

Hearing aid not inserted correctly into charger

i If the problem persists, contact your hearing care professional for assistance.

Please check <https://www.phonak.com/com/en/support.html> for further information.

What to do

Insert hearing aid correctly into charger (chapter 4.1)

26. Important safety information

Please read the relevant safety information and limitations-of-use information on the following pages before using your hearing aid.

Intended use

The hearing aid is intended to amplify and transmit sound to the ear and thereby compensate for impaired hearing.

The Phonak Tinnitus Balance software feature is intended for use by people with tinnitus who also desire amplification. It provides supplementary noise stimulation which can help defocus the user's attention from their tinnitus.

The chargers are intended to charge the battery of the rechargeable hearing aid.

Intended patient population:

Hearing aids: This device is intended for patients with unilateral and bilateral, mild to profound hearing loss from 12 years of age. The tinnitus software feature is intended for patients with chronic tinnitus from 18 years of age.

Charger: The intended patient population is the user of the compatible hearing aids

Intended user:

Hearing aids: Intended for people with hearing loss using a hearing aid and their caregivers. A hearing care professional is responsible for adjusting the hearing aid.

Charger: Intended for people with hearing loss using the compatible rechargeable hearing aid and their caregivers, hearing care professional

Indications:

General clinical indications for the use of hearing aids, charger and Tinnitus software feature are:

Presence of hearing loss

- Uni- or bilateral
- Conductive, sensorineural or mixed
- Mild to profound

Presence of a chronic tinnitus (only applicable for devices which provide the Tinnitus software feature)

Contraindications:

General clinical contra-indications for the use of hearing aids and Tinnitus software feature are:

- Hearing loss is not in the fitting range of the hearing aid (i.e. gain, frequency response)
- Acute tinnitus (< three months after it occurs)
- Deformity of the ear (i.e. closed ear canal; absence of the auricle)
- Neural hearing loss (i.e. retro-cochlear pathologies such as absent / non-viable auditory nerve)

Charger: Please note, contraindications are not derived from the charger, but from the compatible hearing aids.

The primary criteria for the referral of a patient for a medical or other specialist opinion and / or treatment are as follows:

- Visible congenital or traumatic deformity of the ear;
- History of active drainage from the ear in the previous 90 days;
- History of sudden or rapidly progressive hearing loss in one or both ears within the previous 90 days;

- Acute or chronic dizziness;
- Audiometric air-bone gap equal to or greater than 15 dB at 500 Hz, 1000 Hz and 2000 Hz;
- Visible evidence of significant cerumen accumulation or a foreign body in the ear canal;
- Pain or discomfort in the ear;
- Abnormal appearance of the eardrum and ear canal such as:
 - Inflammation of the external auditory canal
 - Perforated eardrum
 - Other abnormalities which the hearing care professional believes are of medical concern

Special care should be exercised in selecting and fitting a hearing aid whose maximum sound pressure level exceeds 132 decibels (dB) because there may be risk of impairing the remaining hearing of the hearing aid user. (This provision is required only for those hearing aids with a maximum sound pressure capability greater than 132 dB).

The hearing care professional may decide that referral is not appropriate or in the best interests of the patient when the following applies:

- When there is sufficient evidence that the condition has been fully investigated by a medical specialist and any possible treatment has been provided;
- The condition has not worsened or changed significantly since the previous investigation and / or treatment.
- If the patient has given their informed and competent decision not to accept advice to seek a medical opinion, it is permissible to proceed to recommend appropriate hearing aid systems subject to the following considerations:
 - The recommendation will not have any adverse effects on the patients health or general well being;
 - The records confirm that all necessary considerations about the patient's best interests have been made

If legally required, the patient has signed a disclaimer to confirm that the referral advice has not been accepted and that it is an informed decision.

Clinical benefit:

Hearing aid: Improvement of speech understanding

Tinnitus feature: Tinnitus feature provides supplementary noise stimulation which can help defocus the user's attention from their tinnitus.

Charger: The Charger itself does not provide a direct clinical benefit. An indirect clinical benefit is provided by enabling the parent device (rechargeable hearing aids) to achieve their intended purpose.

Side effects:

Physiological side-effects of hearing aids like tinnitus, dizziness, wax build up, too much pressure, sweating or moisture, blisters, itching and/or rashes, plugged or fullness and their consequences like headache and/ or ear pain, may be resolved or reduced by your hearing care professional.

Conventional hearing aids have the potential to expose patients to higher levels of sound exposure, which might result in threshold shifts in the frequency range affected by acoustic trauma.

Charger: Please note, side effects are not derived from the charger, but from the compatible hearing aids.

The hearing aid is suitable for the home healthcare environment and due to their portability it may happen that it is used in professional healthcare facility environment like physician offices, dental offices etc.

A hearing aid will not restore normal hearing and will not prevent or improve a hearing impairment resulting from organic conditions. Infrequent use of a hearing aid does not permit a user to attain full benefit from it. The use of a hearing aid is only part of hearing habilitation and may need to be supplemented by auditory training and instruction in lipreading.

Feedback, poor sound quality, too loud or too soft sounds, inadequate fitting or problems when chewing or swallowing, can be resolved or improved during the





fine-tuning process at the fitting procedure by your hearing care professional.





Any serious incident that has occurred in relation to the hearing aid, should be reported to the manufacturer representative and the competent authority of the state of residence. The serious incident is described as any incident that directly or indirectly led, might have led or might lead to any of the following:

- a) the death of a patient, user or other person
- b) the temporary or permanent serious deterioration of a patient's, user's or other person's state of health
- c) a serious public health threat

To report an unexpected operation or event, please contact the manufacturer or a representative.

26.1 Hazard warnings

-  The rechargeable hearing aids contain lithium-ion batteries that can be taken onto airplanes as carry-on luggage. The hearing aids cannot be placed in the checked-in baggage and can only be placed in the carry-on luggage.
-  Your hearing aids operate between 2.4 GHz -2.48 GHz frequency range. When flying please check if flight operator requires devices to be switched into flight mode, see chapter 14.
-  The hearing aids (specially programmed for each hearing loss) must only be used by the intended person. They should not be used by any other person as they could damage hearing.
-  Changes or modifications to the hearing aid and the charger that were not explicitly approved by Sonova AG are not permitted. Such changes may damage your ear or the hearing aid

-  Do not use the hearing aids and charging accessories in explosive areas (mines or industrial areas with danger of explosions, oxygen rich environments or areas where flammable anesthetics are handled) or where electronic equipment is prohibited. The device is not ATEX certified.
-  If you feel pain in or behind your ear, if it is inflamed or if skin irritation and accelerated accumulations of earwax occur, please check with your hearing care professional or physician.
-  Titanium shells of custom hearing aids and earpieces can contain small quantities of acrylates from adhesives. People who are sensitive to such substances may potentially experience an allergic skin reaction. Please stop using the device immediately if such a reaction occurs and check with your hearing care professional or physician.
-  In very rare cases, the dome can remain in your ear canal when removing the hearing tube from the ear. In the unlikely case that the dome does get stuck in your ear canal, it is strongly recommended to see a physician for safe removal.

-  Hearing programs in the directional microphone mode reduce background noises. Please be aware that warning signals or noises coming from behind, e. g. cars, are partially or entirely suppressed.

-  This hearing aid is not for children below 36 months. The usage of this device by children and individuals with cognitive impairment should be supervised at all times to ensure their safety. The hearing aid is a small device and contains small parts. Do not leave children and individuals with cognitive impairment unsupervised with this hearing aid. If swallowed, consult a physician or hospital immediately as the hearing aid or its parts can cause choking!

-  The following is only applicable for persons with active implantable medical devices (i.e. pacemakers, defibrillators, etc.):
- Keep the wireless hearing aid and the charging device at least 15 cm (6 inches) away from the active implant. If you experience any interference, do not use the wireless hearing aids and contact the manufacturer of the active implant. Please, note that interference can also be caused by power lines, electrostatic discharge, airport metal detectors etc.
 - Keep magnets (i.e battery handling tool, EasyPhone magnet, etc.) at least 15 cm (6 inches) away from the active implant.

 Use of this equipment adjacent to or stacked with other equipment should be avoided because it could result in improper operation. If such use is necessary, this equipment and the other equipment should be observed to verify that they are operating normally.

 Use of accessories, transducers and cables other than those specified or provided by the manufacturer of this equipment could result in increased electromagnetic emissions or decreased electromagnetic immunity of this equipment and result in improper operation.

-  Portable RF communications equipment (including peripherals such as antenna cables and external antennas) should be used no closer than 30 cm (12 inches) to any part of the hearing aids and charger, including cables specified by the manufacturer. Otherwise, degradation of the performance of this equipment could result.

-  Hearing aids should not be fitted with domes / wax protection systems when used by clients with perforated eardrums, inflamed ear canals or otherwise exposed middle ear cavities. In these cases, we recommend the use of a custom earpiece. In the unlikely case that any part of this product should remain in the ear canal, it is strongly recommended to see a medical specialist for safe removal.

-  Avoid strong physical impacts to the ear when wearing a hearing aid with customized earpiece. The stability of customized earpieces is designed for normal use. A strong physical impact to the ear (e.g. during sports) may cause the customized earpiece to break. This may lead to perforation of the ear canal or eardrum.

-  After mechanical stress or shock to the customized earpiece, please ensure that it is intact before placing it in the ear.

-  The majority of hearing aid users have a hearing loss for which a deterioration in hearing is not to be expected with regular use of a hearing aid in everyday situations. Only a small group of hearing aid wearers with hearing loss, may be at risk of deterioration in hearing after a long period of use.

-  Do not remove receiver cables from the hearing instruments. If removal or exchange is required it is recommended to contact the hearing care professional.





Patients implanted with magnetic externally programmable CSF shunt valves may have a risk of experiencing an unintended change in their valve setting when exposed to strong magnetic fields.

The receiver (loudspeaker) of hearing aids, the Lyric SoundLync, the Lyric programming wand and the MiniControl contain static magnets. Keep a distance of 2 inches (approx. 5 cm) or more between the magnets and the site of the implanted shunt valve.



WARNING: The hearing aids use a lithium button/coin battery. These batteries are hazardous and can cause severe or fatal injuries in 2 hours or less if they are swallowed or placed inside any part of the body, whether the battery is used or new! Keep out of the reach of children, individuals with cognitive impairment, or pets. If you suspect that a battery was swallowed or placed inside any part of the body, immediately consult your physician without any delay!

-  Your hearing aid(s) contain lithium-ion batteries with a Watt hour rating <20Wh which have been tested according to UN 38.3 of the "UN Manual of Tests and Criteria" and should be shipped in accordance with all the rules and regulations on the safe shipment of lithium-ion batteries.

-  For charger, use only IEC 60950-1 *, IEC 62368-1 or IEC 60601-1 certified equipment with an output rating of 5 VDC. Min. 500 mA.

-  Do not touch the contacts of the charger when powered

*Note: this standard may not be valid anymore in your country, please refer to IEC 62368-1

26.2 Information on product safety

- ① Protect your hearing aid and charging accessories from heat and sunlight (never leave near a window or in the car). Never use a microwave or other heating devices to dry your hearing aid or charging accessories (due to risk of fire or explosion). Ask your hearing care professional about suitable drying methods.

- ① Do not place the hearing aids and charging accessories close to an induction cooking surface. Conductive structures inside the charging accessories could absorb inductive energy resulting in thermal destruction.

- ① The dome should be changed every three months or when it becomes stiff or brittle. This is to prevent the dome from detaching from the tube spout during insertion into or removal from the ear.

- ① Do not drop your hearing aid or charging accessories!
Dropping onto a hard surface can damage your hearing aid or charging accessories.
- ① Charger and power supply must be protected against shocks.
If the charger or power supply is damaged after a shock, the devices must not be used anymore.
- ① If you are not using your hearing aid for a long period of time, store it in a box with a drying capsule or in a well ventilated location. This allows moisture to evaporate from your hearing aid and prevents a potential impact on its performance.

① Special medical or dental examination including radiation described below, may adversely affect the correct functioning of your hearing aids. Remove and keep them outside the examination room/area before undergoing:

- Medical or dental examination with X-ray (also CT scan).
- Medical examinations with MRI/NMRI scans, generating magnetic fields.

Hearing aids don't need to be removed when passing security gates (airports etc.). If X-ray is used at all, it will be in very low doses, and will not affect the hearing aids.

① The hearing aids have to be dry before charging. Otherwise the charging reliability cannot be guaranteed.

① Only use approved charger described in this user guide for charging your hearing aids, otherwise the devices may be damaged.

- ① Make sure that you always completely dry your hearing aid after use. Store the hearing aid in a safe, dry and clean place.
- ① The hearing aids are water resistant and not waterproof. They are designed to withstand normal activities and occasional accidental exposure to extreme conditions. Never immerse your hearing aid in water! Phonak hearing aids are not specifically designed for extended periods of water submersion on a continual basis, that is worn in activities such as swimming or bathing. Always remove your hearing aid before these activities, as the hearing aid contains sensitive electronic parts. Never wash the microphone inputs. Doing so could cause it to lose its special acoustic features.
- ① Do not use your hearing aid or charger in areas where electronic equipment is prohibited.

27. For the US market only, complies with the FDA regulations

Important information: Cell phones

Some hearing aid users have reported a buzzing sound in their hearing aids when they are using cell phones. According to the ANSI 63.19 (American National Standard Methods of Measurement of Compatibility between Wireless Communications Devices and Hearing Instruments) standard, the compatibility of a particular hearing aid and cell phone can be predicted by adding the rating for the hearing aid immunity to the rating for the cell phone emissions. The sum of the hearing aid rating (e.g. M2/T2=2) and the telephone rating (e.g. M3/T3=3) is 5, and any combination that equals 5 will provide "normal use"; a sum of 6 or greater would indicate "excellent performance". The equipment performance measurements, categories and system classifications are based upon the best information available but cannot guarantee that all users will be satisfied. The immunity of this hearing aid is at least M2/T2.

Note: the performance of individual hearing aids may vary with individual cell phones. Therefore, please try the hearing aid with your cell phone or, if you are purchasing a new phone, be sure to try it with your hearing aid prior to purchase. For additional guidance, please ask your hearing care professional for the booklet entitled "hearing aid compatibility with digital wireless cell phones".

Important information in case of battery ingestion

If a battery is swallowed, call the 24-hour National Battery Ingestion Hotline at 202-625-3333 or consult your physician immediately.

Warning to hearing aid dispensers

A hearing aid dispenser should advise a prospective hearing aid user to consult promptly with a licensed physician (preferably an ear specialist) before dispensing a hearing aid if the hearing aid dispenser determines through inquiry, actual observation, or review of any other available information concerning the prospective user, that the prospective user has any of the following conditions:

- (i) Visible congenital or traumatic deformity of the ear.
- (ii) History of active drainage from the ear within the previous 90 days.
- (iii) History of sudden or rapidly progressive hearing loss within the previous 90 days.
- (iv) Acute or chronic dizziness.

- (v) Unilateral hearing loss of sudden or recent onset within the previous 90 days.
- (vi) Audiometric air-bone gap equal to or greater than 15 decibels at 500 hertz (Hz), 1,000 Hz, and 2,000 Hz.
- (vii) Visible evidence of significant cerumen accumulation or a foreign body in the ear canal.
- (viii) Pain or discomfort in the ear. Special care should be exercised in selecting and fitting a hearing aid whose maximum sound pressure level exceeds 132 decibels because there may be risk of impairing the remaining hearing of the hearing aid user. (This provision is required only for those hearing aids with a maximum sound pressure capability greater than 132 decibels (dB).)

Important notice for prospective hearing aid users

Good health practice requires that a person with a hearing loss have a medical evaluation by a licensed physician (preferably a physician who specializes in diseases of the ear) before purchasing a hearing aid. Licensed physicians who specialize in diseases of the ear are often referred to as otolaryngologists, otologists or otorhinolaryngologists. The purpose of medical evaluation is to assure that all medically treatable conditions that may affect hearing are identified and treated before the hearing aid is purchased.

Following the medical evaluation, the physician will give you a written statement that states that your hearing loss has been medically evaluated and that you may be considered a candidate for a hearing aid. The physician will refer you to an audiologist or a hearing aid dispenser, as appropriate, for a hearing aid evaluation.

The audiologist or hearing aid dispenser will conduct a hearing aid evaluation to assess your ability to hear with and without a hearing aid. The hearing aid evaluation will enable the audiologist or dispenser to select and fit a hearing aid to your individual needs.

If you have reservations about your ability to adapt to amplification, you should inquire about the availability of a trial-rental or purchase-option program. Many hearing aid dispensers now offer programs that permit you to wear a hearing aid for a period of time for a nominal fee after which you may decide if you want to purchase the hearing aid.

Federal law restricts the sale of hearing aids to those individuals who have obtained a medical evaluation from a licensed physician. Federal law permits a fully informed adult to sign a waiver statement declining the medical evaluation for religious or personal beliefs that preclude

consultation with a physician. The exercise of such a waiver is not in your best health interest and its use is strongly discouraged.

Children with hearing loss

In addition to seeing a physician for a medical evaluation, a child with a hearing loss should be directed to an audiologist for evaluation and rehabilitation since hearing loss may cause problems in language development and the educational and social growth of a child. An audiologist is qualified by training and experience to assist in the evaluation and rehabilitation of a child with a hearing loss.

Important notice for prospective noise generator users

The Tinnitus Balance noise generator is a broadband sound Generator which may have been enabled in your hearing aid. It provides a means of sound enrichment that can be used as part of a personalized tinnitus management program

to provide temporary relief from tinnitus. It should always be used as prescribed by your audiologist. The underlying principle of sound enrichment is to provide supplementary noise stimulation which can help defocus your attention from your tinnitus and avoid negative reactions. Sound enrichment, coupled with instructional counseling, is an established approach to managing tinnitus.

Good health practice requires that a person reporting tinnitus have a medical evaluation by a licensed ear physician before using a sound generator. The purpose of such an evaluation is to ensure medically treatable conditions that may be causing tinnitus are identified and treated prior to using a sound generator.

Should you develop any side effects whilst using the noise generator such as headaches, nausea, dizziness or heart palpitations or experience a decrease in auditory function, you should discontinue use and seek a medical evaluation.

According to OSHA (Occupational Safety & Health Administration, U.S. Department of Labor) regulations, the volume of the noise generator can be set to a level which could lead to permanent hearing damage when used for a prolonged period of time. Should the noise generator be set to such a level in your hearing aid, your audiologist will advise you of the maximum amount of time per day you should use the noise generator. The noise generator should never be used at uncomfortable levels.

For more information visit www.phonak.com



Notes



Notes



Your hearing care professional:



Manufacturer:

Sonova AG
Laubisrütistrasse 28
CH-8712 Stäfa
Switzerland
www.phonak.com

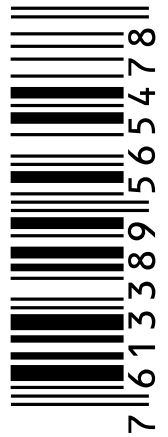

029-1200-03/V1.02/2022-07/NLG/hc © 2022 Sonova AG. All rights reserved.

